

## Dutch Canopies 55 x 15 mm, 100 x 15 mm and accessories

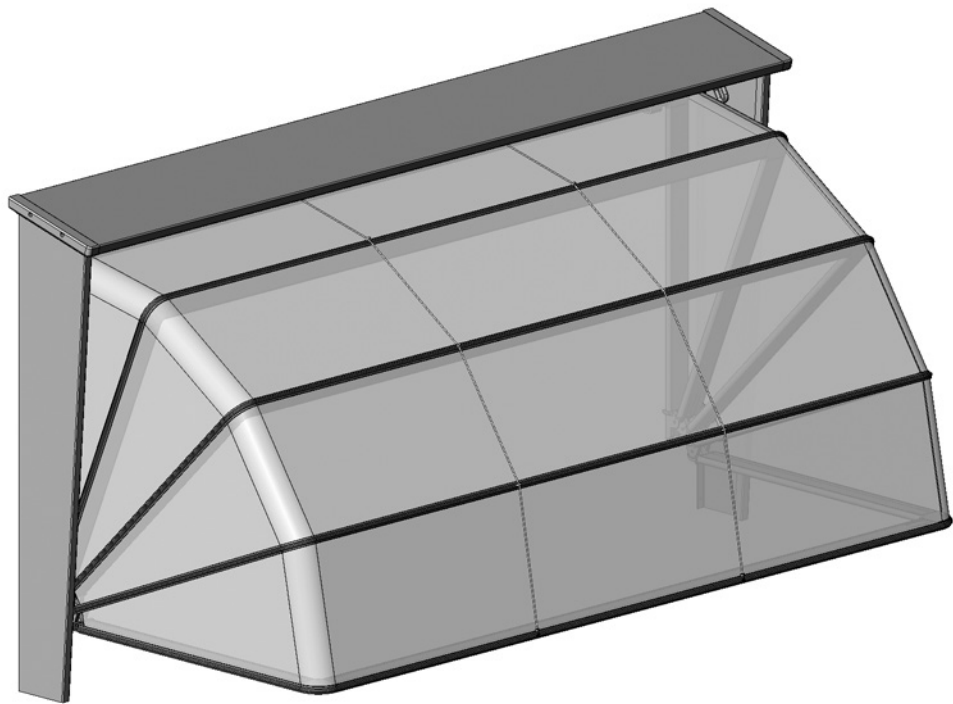

## Dutch Canopies 55 x 15 mm, 100 x 15 mm and accessories

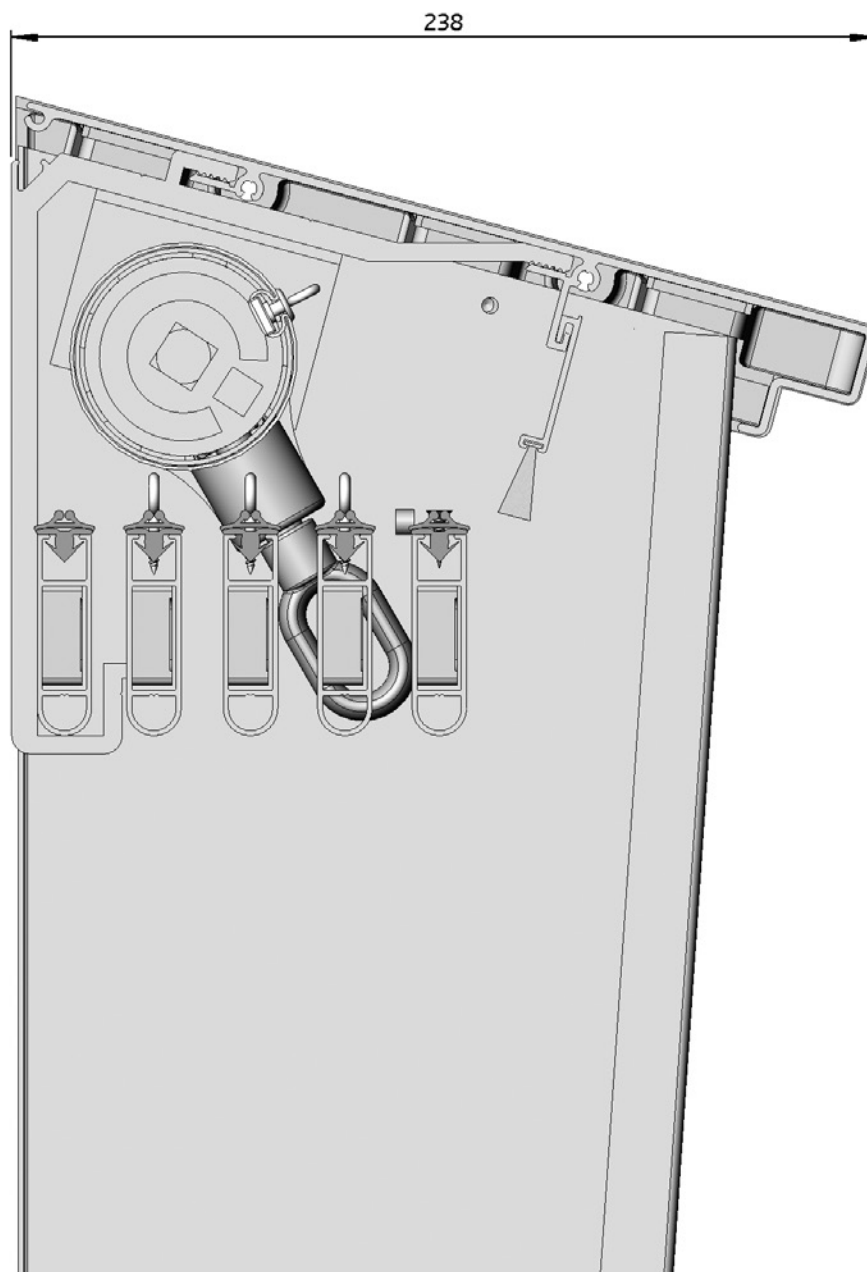

## Dutch Canopies 55 x 15 mm, 100 x 15 mm and accessories

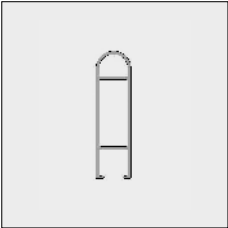
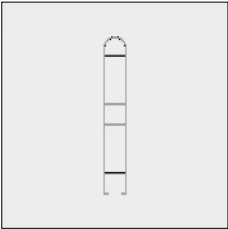
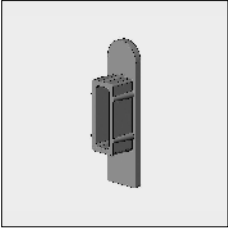
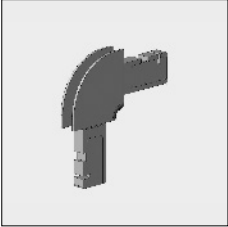
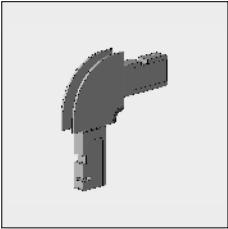
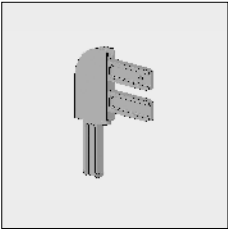
Part number	Description	Paint finish	Length in m <sup>1</sup> Pack. Unit
	6296 013-000	Alu base profile 55 x 15 mm (hard)	Mill finish 7.5
	6296 012-016	Alu base profile 55 x 15 mm (soft)	Silver anodized 6.0
	6296 013-016	Idem, (hard)	Silver anodized 7.5
	6296 013-006	Alu base profile 55 x 15 mm (hard)	RAL 9010 pure white 7.5
	6296 013-901	Idem, hard	RAL 9001 cream 7.5
	6296 030-000	Alu base profile 100 x 15 mm (hard)	Mill finish 6.0
	6296 030-016	Idem	Silver anodized 6.0
	6296 030-901	Idem	RAL 9001 cream 6.0
<p><b>Note: If the top board Classic is used, base profile 55x15 mm has to be used with the wall brackets!</b></p>			
	4200 043-000	Nylon end cap for base profile 55 x 15 mm	Black
	4000 236-000	Alu fixed corner for base profile 55 x 15 mm, radius 60	Mill finish
	4000 236-008	Idem	RAL 7035 light grey
	4000 236-006	Idem	RAL 9010 pure white
	4000 236-901	Idem	RAL 9001 cream
	4000 236-115	# Idem	RAL 1015 light ivory
	4200 122-008	Nylon fixed corner for base profile 55 x 15 mm, radius 60	Grey "7035"
	4200 122-006	Idem	White "9010"
	4200 122-901	Idem	Cream "9001"
	4000 249-000	Alu fixed corner for base profile 100 x 15 mm, radius 50	Mill finish
	4000 249-008	Idem	RAL 7035 light grey
	4000 249-901	Idem	RAL 9001 cream

# = Article will be sold out. Special orders remain possible.

## Dutch Canopies 55 x 15 mm, 100 x 15 mm and accessories

	Part number	Description	Paint finish	Length in m <sup>2</sup> Pack. Unit
	4000 271-000	Alu adjustable corner for base profile 55 x 15 mm	Mill finish	
	4000 238-901	Alu hinge 4 legs for base profile 55 x 15 mm (not assembled)	RAL 9001 cream	
	4000 239-008	Alu hinge 5 legs for base profile 55 x 15 mm (not assembled)	RAL 7035 light grey	
	4000 239-006	Idem	RAL 9010 pure white	
	4000 239-901	Idem	RAL 9001 cream	
	4000 239-115	# Idem	RAL 1015 light ivory	
	4000 245-000	Alu adapter (cap model) for base profile 55 x 15 mm	Mill finish	
	4000 245-008	Idem	RAL 7035 light grey	
	4000 245-901	Idem	RAL 9001 cream	
	4000 240-000	Alu hinge part 1 (wall bracket) for base profile 55 x 15 mm	Mill finish	
	4000 240-008	Idem	RAL 7035 light grey	
	4000 240-006	Idem	RAL 9010 pure white	
	4000 240-901	Idem	RAL 9001 cream	
	4000 241-000	Alu hinge part 2 (couple part) for base profile 55 x 15 mm	Mill finish	
	4000 241-008	Idem	RAL 7035 light grey	
	4000 241-006	Idem	RAL 9010 pure white	
	4000 241-901	Idem	RAL 9001 cream	
	4000 242-000	Alu hinge part 3 (front part) for base profile 55 x 15 mm	Mill finish	
	4000 242-008	Idem	RAL 7035 light grey	
	4000 242-006	Idem	RAL 9010 pure white	
	4000 242-901	Idem	RAL 9001 cream	



# = Article will be sold out. Special orders remain possible.

## Dutch Canopies 55 x 15 mm, 100 x 15 mm and accessories

Part number	Description	Paint finish	Length in m <sup>1</sup> Pack. Unit
4200 118-901	Nylon hinge 4 legs for base profile 55 x 15 mm (not assembled)	Cream "9001"	
4200 120-008	Nylon hinge 5-legs for base profile 55 x 15 mm (not assembled)	Grey "7035"	
4200 120-006	Idem	White "9010"	
4200 120-901	Idem	Cream "9001"	
4200 124-008	Nylon hinge part 1 (wall bracket) for base profile 55 x 15 mm	Grey "7035"	
4200 124-006	Idem	White "9010"	
4200 124-901	Idem	Cream "9001"	
4200 126-008	Nylon hinge part 2 (couple part) for base profile 55 x 15 mm	Grey "7035"	
4200 126-006	Idem	White "9010"	
4200 126-901	Idem	Cream "9001"	
4200 128-008	Nylon hinge part 3 (front part) for base profile 55 x 15 mm	Grey "7035"	
4200 128-006	Idem	White "9010"	
4200 128-901	Idem	Cream "9001"	
4000 243-000	Spring dowel to connect the alu and nylon hinge parts 1, 2 and 3		100
4000 235-000	Nylon filling profile for base profiles 55 x 15 mm and 100x15 mm (rolls of 200 m.)	Grey	
4000 246-901	Alu linker for base profiles 55 x 15 mm and 100 x 15 mm	RAL 9001 cream	



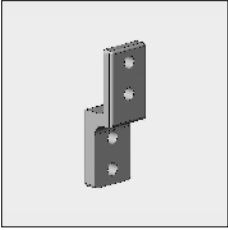
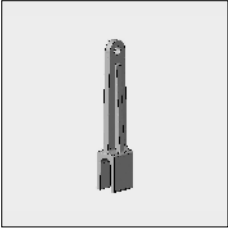
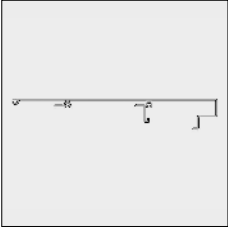
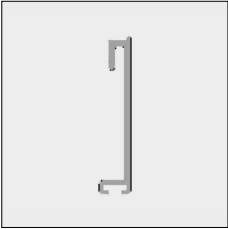

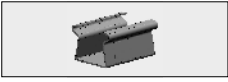
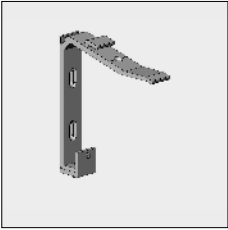
# = Article will be sold out. Special orders remain possible.

## Dutch Canopies 55 x 15 mm, 100 x 15 mm and accessories

	Part number	Description	Paint finish	Length in m <sup>1</sup> Pack. Unit
	4000 399-008	Alu wall bracket for base profiles 55 x 15 mm and 100 x 15 mm	RAL 7035 light grey	
	4000 399-901	Idem	RAL 9001 cream	
	4000 247-000	Alu cord guide, for base profiles 55 x 15 mm and 100 x 15 mm	Mill finish	
	4000 247-008	Idem	RAL 7035 light grey	
	4000 247-006	Idem	RAL 9010 pure white	
	4000 247-901	Idem	RAL 9001 cream	
	6296 024-000	Alu top board base Classic 242 mm	Mill finish	7.5
	6296 024-016	Idem	Silver anodized	7.5
	6296 024-006	Idem	RAL 9010 pure white	7.5
	6296 024-901	Idem	RAL 9001 cream	7.5
	6296 024-115	# Idem	RAL 1015 light ivory	7.5
	6296 021-000	Alu bristle profile	Mill finish	7.5
	6296 021-016	Idem	Silver anodized	7.5
	6296 021-006	Idem	RAL 9010 pure white	7.5
	6296 021-901	Idem	RAL 9001 cream	7.5
	6296 021-609	# Idem	RAL 6009 fir green	7.5
	4200 260-000	Bristle	Grey	125
<b>To clamp the bristle profile into the top board the following items can be used:</b>				
	4452 074-009	Steel clamp for bristle profile	Zinc-plated	
	4200 257-090	Alu wall bracket (2-pieces) for top board Classic and base profile 55 x 15 mm	Mill finish	10
	4200 257-008	Idem	RAL 7035 light grey	10
	4200 257-006	Idem	RAL 9010 pure white	10
	4200 257-901	Idem	RAL 9001 cream	10
	4200 257-115	# Idem	RAL 1015 light ivory	10
	4200 257-609	# Idem	RAL 6009 fir green	10

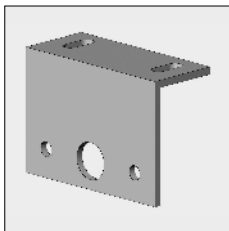
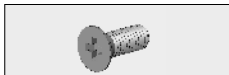

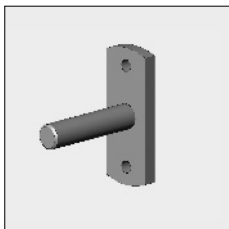

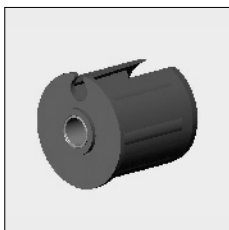
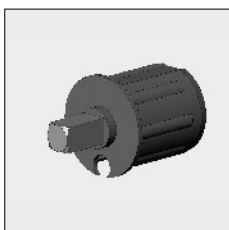
# = Article will be sold out. Special orders remain possible. **If a steel roller 63 or 48 is used for the operation, this roller can be mounted as follows:**

## Dutch Canopies 55 x 15 mm, 100 x 15 mm and accessories

Part number	Description	Paint finish	Length in m <sup>1</sup> Pack. Unit
	4200 250-001 Alu wall bracket	Silver anodized	
<b>To fix the wall bracket use:</b>			
	4000 154-000 Stainless steel screw with countersunk Philips head M 6 x 16 mm		50
	4000 281-000 Stainless steel nut M6		100
<b>On the bearing side use:</b>			
	4210 498-080 Bearing pin 12 mm with fixing plate	Zinc-plated	10
<b>To fix the wall bracket use:</b>			
	4000 270-000 Stainless steel screw with Philips cylinder head M 6 x 12 mm		100
	4410 402-000 Stainless steel washer M6 (2 pcs. per screw)		100
<b>To be used on the operational side:</b>			
- Either motor bracket + motor			
- Or gear box with eye (spindle 4000 513-000)			
- Or gear box without eye (spindle 4000 514-000)			
- Or bearing pin (with strip or cord operation)			
	4470 058-068 Nylon bearing roller bung 48 with slide bearing		10
	4452 224-068 Nylon bearing roller bung 63 with precision bearing		10
	4470 062-080 Nylon roller bung 48 with square spindle 13 x 30 mm		25
	4470 032-080 Nylon roller bung 63 with square spindle 13 x 25 mm		25

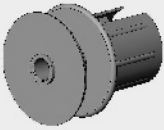
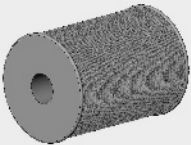
# = Article will be sold out. Special orders remain possible.

## Dutch Canopies 55 x 15 mm, 100 x 15 mm and accessories

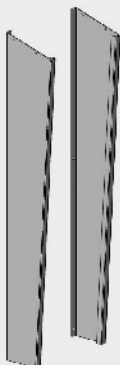
Part number	Description	Paint finish	Length in m <sup>1</sup> Pack. Unit
4470 056-080	Nylon bearing roller bung 48 with pulley 65 mm, spindle hole 12 mm (for manual tape 18 mm)		25
			
4215 155-000	Cord 2.5 mm	White	100
			
<b>Note: For operation on top by using a roller. For operation underneath, use the cord 4.2 or 6 mm.</b>			
4000 277-000	Nylon screw eye with nut (for fixing the cord to the roller)		100
			
4000 275-000	Screw eye/cord guide (to be fixed on the nylon insert strip in the base profile)	White	100
			
4000 276-000	Alu cord eye (for fixing the cord to the screw eye in the front profile)		100
			
4200 201-090	Alu side board Classic 105 cm, per pair	Mill finish	
4200 201-001	Idem	Silver anodized	
4200 201-006	Idem	RAL 9010 pure white	
4200 201-901	Idem	RAL 9001 cream	
4200 201-115	# Idem	RAL 1015 light ivory	
			
4200 191-090	Alu side board Classic 120 cm, per pair	Mill finish	
4200 191-001	Idem	Silver anodized	
4200 191-006	Idem	RAL 9010 pure white	
4200 191-901	Idem	RAL 9001 cream	
4200 205-090	Alu side board Classic 135 cm, per pair	Mill finish	
4200 205-001	Idem	Silver anodized	
4200 205-006	Idem	RAL 9010 pure white	
4200 205-901	Idem	RAL 9001 cream	
4200 209-090	Alu side board Classic 150 cm, per pair	Mill finish	
4200 209-001	Idem	Silver anodized	
4200 209-006	Idem	RAL 9010 pure white	
4200 209-901	Idem	RAL 9001 cream	

# = Article will be sold out. Special orders remain possible.



## Dutch Canopies 55 x 15 mm, 100 x 15 mm and accessories

Part number	Description	Paint finish	Length in m <sup>1</sup> Pack. Unit
-------------	-------------	--------------	--



4200 040-000	Nylon protection strip for alu side board	Transparent	1.6
--------------	---	-------------	-----

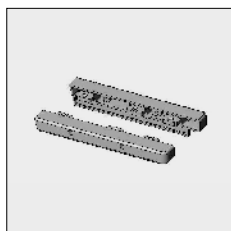

4200 241-090	Alu end part top board Classic, per pair	Mill finish	
4200 241-008	Idem	RAL 7035 light grey	
4200 241-006	Idem	RAL 9010 pure white	
4200 241-901	Idem	RAL 9001 cream	

**For fixing the alu side board to the end part of the top board:**



4210 150-000	Stainless steel plate screw with Philips cylinder head 4.2 x 9.5 mm		100
--------------	---	--	-----

**For fixing the end part and the side board to the top board:**

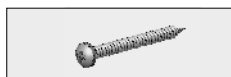

4210 151-000	Stainless steel plate screw with Philips cylinder head 4.2 x 45 mm		100
--------------	--	--	-----

**Note: It is also possible to fix a wooden side board, by using the end parts of the top board.**

**The screw holes of the end part can be sealed with:**



5755 082-008	Nylon end cap 10 mm	Grey	500
5755 082-006	Idem	White	500
5755 082-007	Idem	Brown	500
5755 082-901	Idem	Cream "9001"	500
5755 082-115 #	Idem	Light ivory "1015"	500
5755 082-609	Idem	Fir green "6009"	500
5755 082-513 #	Idem	Cobalt blue "5013"	500
5755 082-511	Idem	Steel blue "5011"	500
5755 082-716	Idem	Anthracite grey "7016"	500
5755 082-905	Idem	Jet black "9005"	500
5755 082-906	Idem	Aluminium "9006"	500
5755 082-305	Idem	Wine red "3005"	500

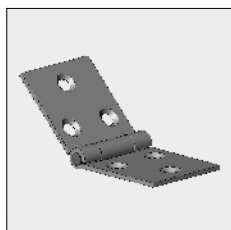



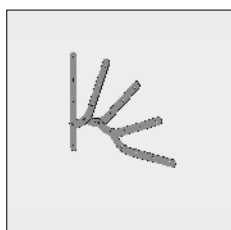

4000 279-000	Steel hinge 44 x 101 mm with copper pin	Zinc-plated	25
--------------	---	-------------	----



4000 264-000	Steel hinge with 5 legs	Galvanized	20
--------------	-------------------------	------------	----

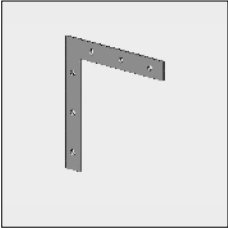

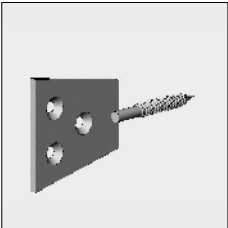
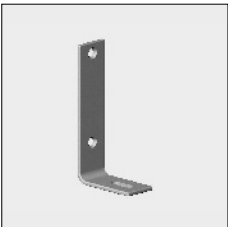

# = Article will be sold out. Special orders remain possible.

## Dutch Canopies 55 x 15 mm, 100 x 15 mm and accessories

	Part number	Description	Paint finish	Length in m <sup>1</sup> Pack. Unit
	4000 266-000	Steel corner 15 x 15 cm	Galvanized	
	4000 253-000	Steel fixing bracket large model (vertical holes) with length hole	Galvanized	
	4000 255-000	Steel fixing bracket 12 cm	Galvanized	20
	4000 255-901	Idem	RAL 9001 cream	20
	4000 256-000	Steel fixing bracket 15 cm	Galvanized	20
	4000 256-901	Idem	RAL 9001 cream	20
	4000 262-000	Steel swallowtail	Galvanized	50
	4000 262-901	Idem	RAL 9001 cream	
	4000 274-000	Steel corner 100 x 47 mm	Galvanized	
	4000 274-901	Idem	RAL 9001 cream	
	4000 257-000	Steel cord wheel with screw eye	Zinc-plated	
	4000 261-000	Spare screw eye	Galvanized	100

# = Article will be sold out. Special orders remain possible.

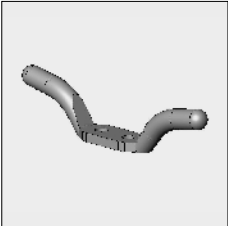
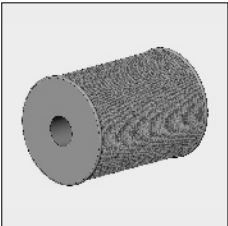
## Dutch Canopies 55 x 15 mm, 100 x 15 mm and accessories

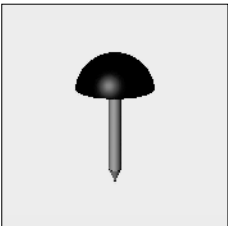
Part number	Description	Paint finish	Length in m <sup>1</sup> Pack. Unit
	4460 070-000 Nylon cord guide	White	50
	4460 090-000 Nylon cleat	White	25
	4000 259-000 Steel cleat 11 cm	Galvanized	50
	4000 260-000 Idem, 13 cm	Galvanized	50
	4460 060-000 Nylon cord 4.2 mm	Black/white	100
	4460 065-000 Idem	White	100
	4000 740-916 Polyester trim for nails	White	250
	4000 740-114 Idem (delivery on demand)	Ivory "RAL 1014"	250
	4000 740-609 Idem	Dark green	250
	4000 740-905 # Idem	Black	250
	4000 720-000 Nail	Black	1000
	4000 721-000 Idem	Light grey	1000
	4000 722-000 Idem	White	1000
	4000 723-000 # Idem	Blue	1000
	4000 735-000 Idem	Dark blue	1000
	4000 724-000 # Idem	Light red	1000
	4000 725-000 Idem	Beige	1000
	4000 726-000 # Idem	Yellow	1000
	4000 732-000 Idem	Dark green	1000
	4000 733-000 Idem	Dark red	1000
	4000 734-000 Idem	Ivory	1000

# = Article will be sold out. Special orders remain possible.

## Dutch Canopies 55 x 15 mm, 100 x 15 mm and accessories

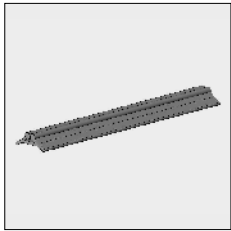

Part number	Description	Paint finish	Length in m <sup>1</sup> Pack. Unit
4000 680-080	Profile decoration	White	300
4000 681-080	Idem	Camel	300
4000 682-080	Idem	Grey	300
4000 683-080	Idem	Black	300
4000 684-080	Idem	Dark green	300
4000 685-080	Idem	Cream	300
4000 686-080	Idem	Red	300
4000 688-080	Idem	Bordeaux red	300
4000 689-080	Idem	Marine blue	300