

Gastro Awning Twins® Piazzola® / Twins® Solidare®

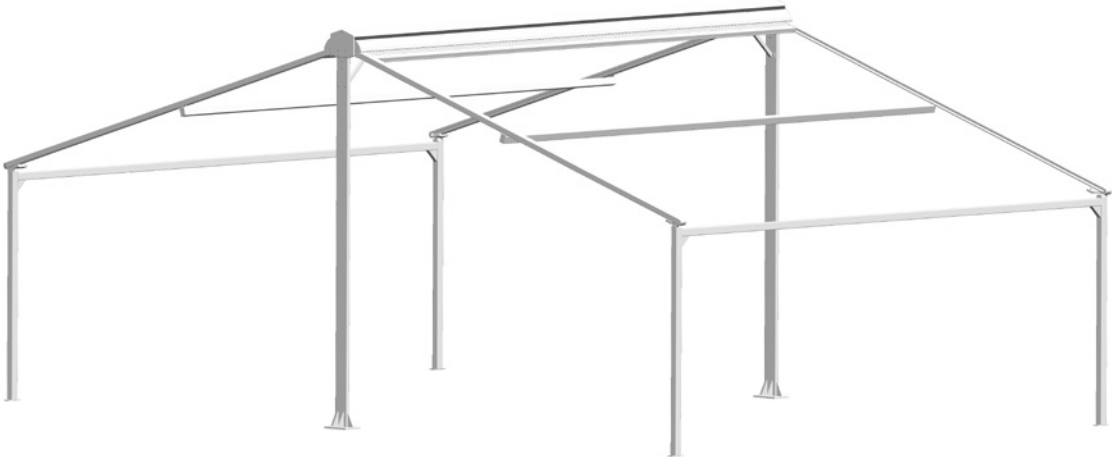
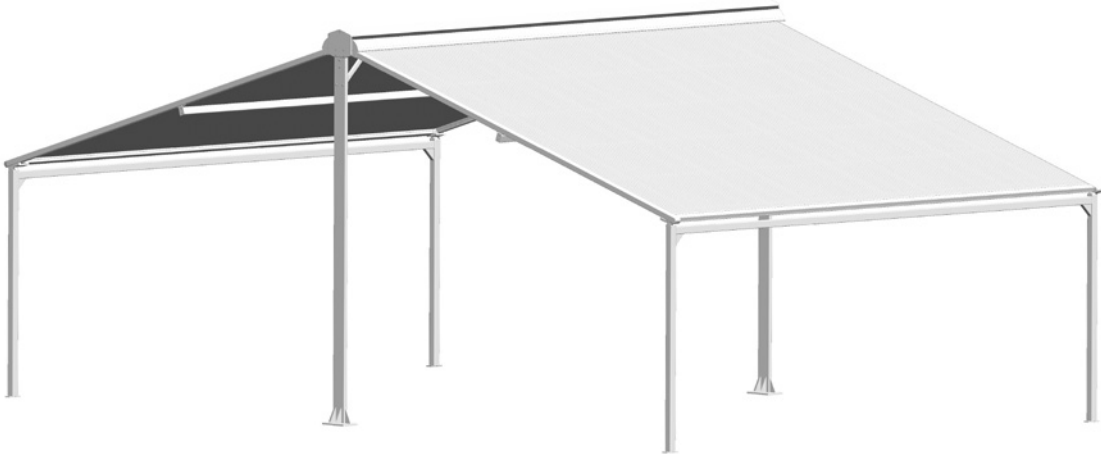

7

= Article will be sold out. Special orders remain possible.

Gastro Awning Twins® Piazzola® / Twins® Solidare®

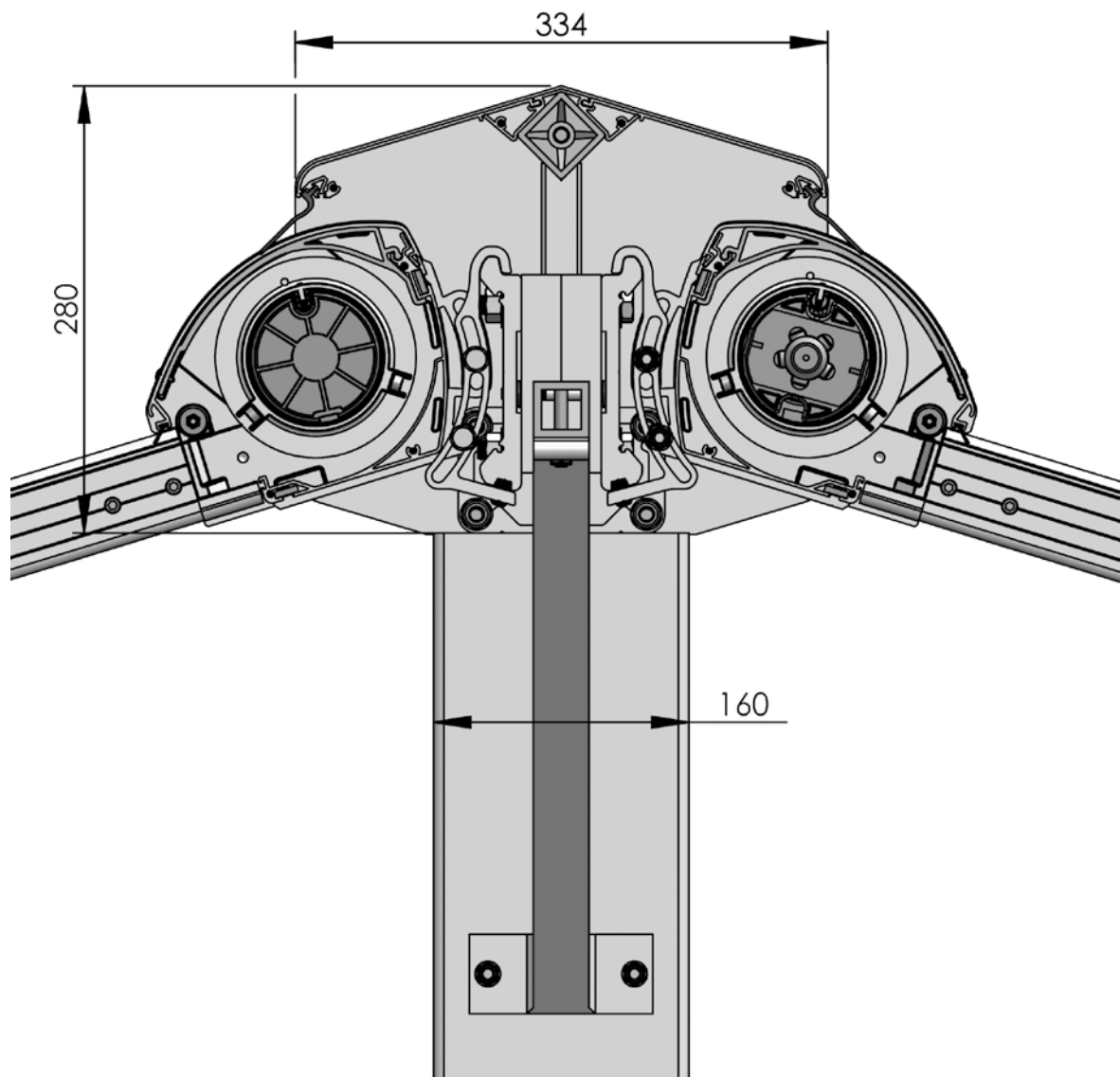

Gastro Awning Twins® Piazzola® / Twins® Solidare®

Part number	Description	Paint finish	Length in m ¹ Pack. Unit
-------------	-------------	--------------	--

The Twins is to be constructed out of 2 Piazzola patio awnings (refer for the required parts Chapter Piazzola or Solidare) which with the parts below are connected with each other.

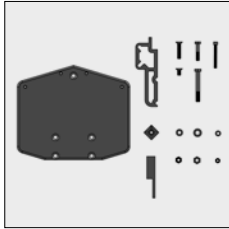

4216 124-090	Parts kit Twins	Mill finish	
4216 124-006	Idem	RAL 9010 pure white	
4216 124-755	Idem (* = Textured)	RAL 7016 anthracite grey*	

The Parts kit contains the following parts:

- Alu side plates including fixing materials
- Brackets including fixing materials. On this you can mount the wall plates (6 pieces = 3 per side) of the Piazzola/Gota (4211 772-...).



4216 203-090	Alu support leg Twins with base plate	Mill finish	4.0
4216 203-006	Idem	RAL 9010 pure white	4.0
4216 203-755	Idem (* = Textured)	RAL 7016 anthracite grey*	4.0

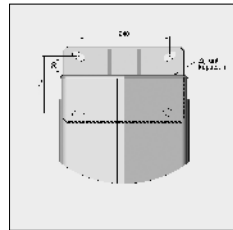
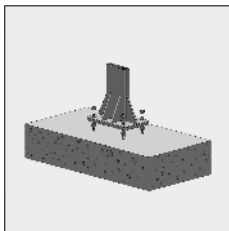

Note: the base plate should be at least 140 x 70 x 40 cm (lxwxh).

4216 217-090	Alu strut with fixing materials for Twins	Mill finish	
4216 217-006	Idem	RAL 9010 pure white	
4216 217-755	Idem (* = Textured)	RAL 7016 anthracite grey*	

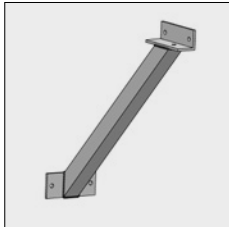

4216 140-090	Alu support beam for Twins (length 6 m.)	Mill finish	
4216 140-006	Idem	RAL 9010 pure white	
4216 140-755	Idem (* = Textured)	RAL 7016 anthracite grey*	

Note: Always cut the roller equally at both sides and when measuring the width, consider the centre pieces between the two rollers.



6295 830-000	Alu top cover for Twins	Mill finish	6.0
6295 830-006	Idem	RAL 9010 pure white	6.0
6295 830-755	Idem (* = Textured)	RAL 7016 anthracite grey*	6.0

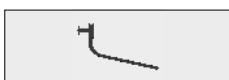

7700 102-000	Rubber for top cover Twins	Black	60
--------------	----------------------------	-------	----

= Article will be sold out. Special orders remain possible.

Gastro Awning Twins® Piazzola® / Twins® Solidare®

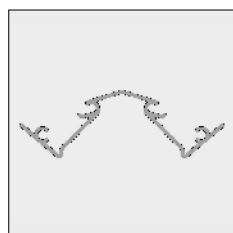

Part number	Description	Paint finish	Length in m ¹ Pack. Unit
6295 810-000	Alu cover connection profile for Twins	Mill finish	6.0
6295 810-006	Idem	RAL 9010 pure white	6.0
6295 810-755	Idem (* = Textured)	RAL 7016 anthracite grey*	6.0



4000 215-000	Stainless steel cross screw, cylinder screw 3.5 x 13 mm (for fixing the cover connection profile to the support beam)		100
--------------	--	--	-----