

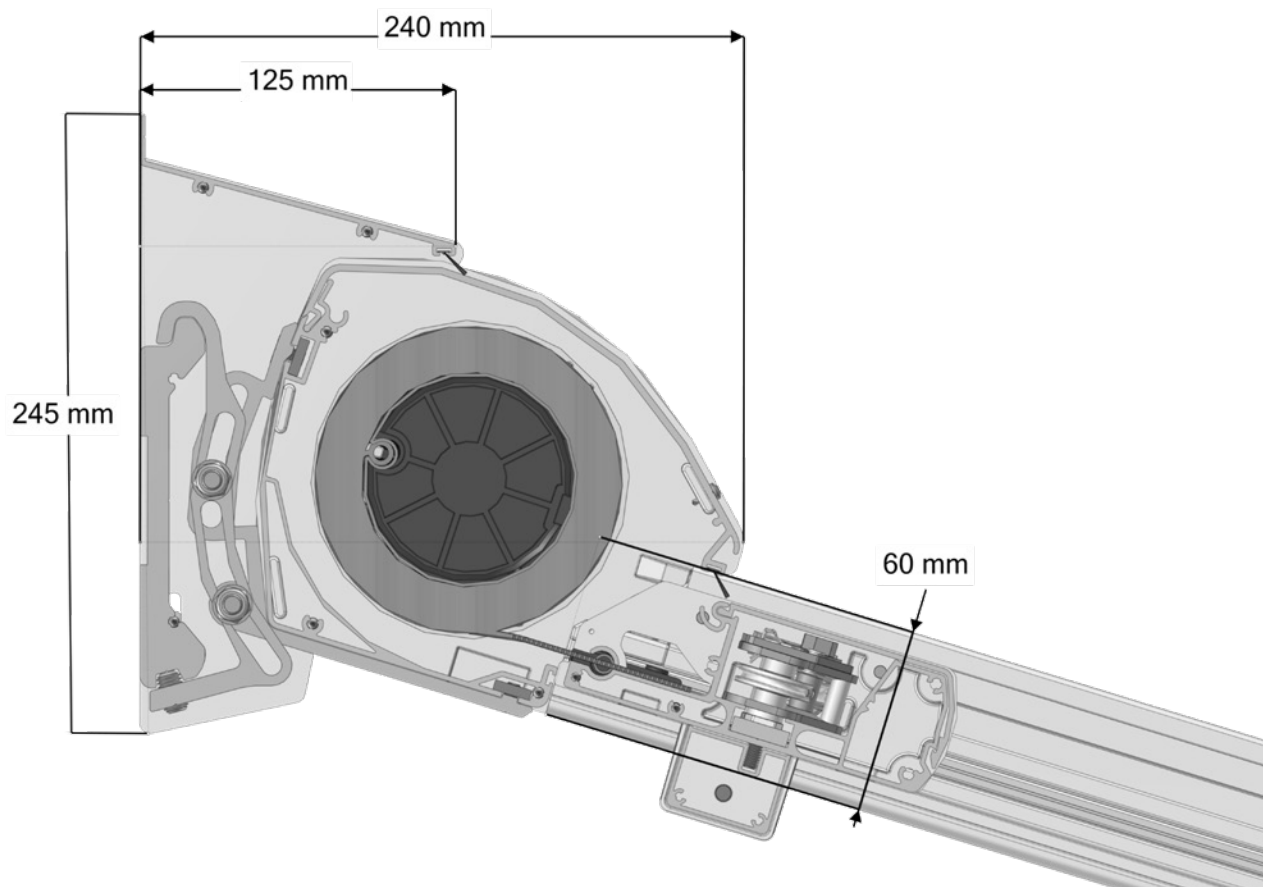

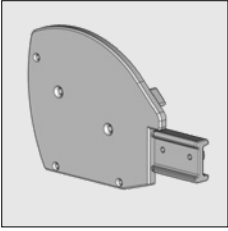

Pergola Awning Solidare®

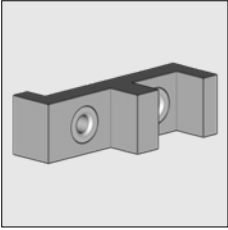
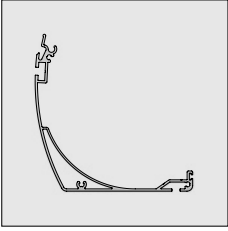
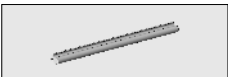

| Artikelnummer | Omschrijving | Uitvoering | Lengte in m ¹ Verp. eenh. |
|---|---|---------------------------|---|
|  | 4217 355-090 Alu end fix bracket Solidare, left | Mill finish | |
| | 4217 357-090 Idem, right | Mill finish | |
| | 4217 355-006 Alu end fix bracket Solidare, left | RAL 9010 pure white | |
| | 4217 357-006 Idem, right | RAL 9010 pure white | |
| | 4217 355-901 Alu end fix bracket Solidare, left | RAL 9001 cream | |
| | 4217 357-901 Idem, right | RAL 9001 cream | |
| | 4217 355-755 Alu end fix bracket Solidare, left (* = Textured) | RAL 7016 anthracite grey* | |
| | 4217 357-755 Idem, right | RAL 7016 anthracite grey* | |
|  | 4217 310-000 Drilling template piece for side guide (to fasten the top cover support to the side guide) | | |
|  | 6252 148-000 Alu bottom cover Piazzola/Solidare | Mill finish | 4.0 |
| | 6252 154-000 Idem | Mill finish | 5.0 |
| | 6252 150-000 Idem | Mill finish | 6.0 |
| | 6252 152-000 Idem | Mill finish | 7.0 |
| | 6252 148-006 Alu bottom cover Piazzola/Solidare | RAL 9010 pure white | 4.0 |
| | 6252 154-006 Idem | RAL 9010 pure white | 5.0 |
| | 6252 150-006 Idem | RAL 9010 pure white | 6.0 |
| | 6252 152-006 # Idem | RAL 9010 pure white | 7.0 |
| | 6252 148-901 # Alu bottom cover Piazzola/Solidare | RAL 9001 cream | 4.0 |
| | 6252 154-901 Idem | RAL 9001 cream | 5.0 |
| | 6252 150-901 Idem | RAL 9001 cream | 6.0 |
| | 6252 148-755 Alu bottom cover Piazzola/Solidare (* = Textured) | RAL 7016 anthracite grey* | 4.0 |
| | 6252 154-755 Idem | RAL 7016 anthracite grey* | 5.0 |
| | 6252 150-755 Idem | RAL 7016 anthracite grey* | 6.0 |
| | 6252 152-755 Idem | RAL 7016 anthracite grey* | 7.0 |
|  | 4211 130-080 Nylon sealing strip for stopper in bottom cover | Black | 50 |
| | 4211 132-080 Idem | White | 50 |
|  | 4210 142-000 Stainless steel plate screw countersunk Philips head 4.2 x 32 mm (to fix bottom cover to the end fix bracket) | | 100 |



= Article will be sold out. Special orders remain possible.

Pergola Awning Solidare®

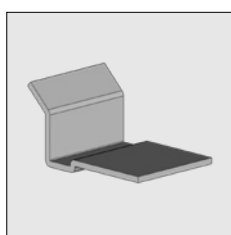
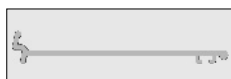
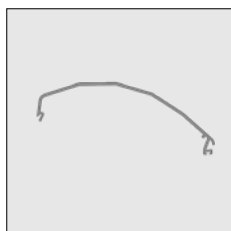
| Artikelnummer | Omschrijving | Uitvoering | Lengte in m ¹ Verp. eenh. |
|---|---|---------------------------|---|
| 6252 300-000 | Alu top cover Solidare | Mill finish | 4.0 |
| 6252 304-000 | Idem | Mill finish | 5.0 |
| 6252 308-000 | Idem | Mill finish | 6.0 |
| 6252 300-006 | Alu top cover Solidare | RAL 9010 pure white | 4.0 |
| 6252 304-006 | Idem | RAL 9010 pure white | 5.0 |
| 6252 308-006 | Idem | RAL 9010 pure white | 6.0 |
| 6252 300-901 | Alu top cover Solidare | RAL 9001 cream | 4.0 |
| 6252 304-901 | Idem | RAL 9001 cream | 5.0 |
| 6252 308-901 | Idem | RAL 9001 cream | 6.0 |
| 6252 300-755 | Alu top cover Solidare (* = Textured) | RAL 7016 anthracite grey* | 4.0 |
| 6252 304-755 | Idem | RAL 7016 anthracite grey* | 5.0 |
| 6252 308-755 | Idem | RAL 7016 anthracite grey* | 6.0 |
| The top cover can be extended with profile 6295 980/984/988. Always apply this cover extension for the Cubola. | | | |
| 6295 980-000 | Alu cover extension | Mill finish | 4.0 |
| 6295 984-000 | Idem | Mill finish | 5.0 |
| 6295 988-000 | Idem | Mill finish | 6.0 |
| 6295 980-006 | Alu cover extension | RAL 9010 pure white | 4.0 |
| 6295 984-006 | Idem | RAL 9010 pure white | 5.0 |
| 6295 988-006 | Idem | RAL 9010 pure white | 6.0 |
| 6295 980-755 | Alu cover extension (* = Textured) | RAL 7016 anthracite grey* | 4.0 |
| 6295 984-755 | Idem (* = Textured) | RAL 7016 anthracite grey* | 5.0 |
| 6295 988-755 | Idem (* = Textured) | RAL 7016 anthracite grey* | 6.0 |
| 4217 345-000 | Bracket to support cover extension. Apply upward of 4.5 m. width | | |
| 4215 190-080 | Bristle for top cover | Black | 25 |
| 4215 190-000 | Idem | Black | 500 |
| 4217 190-000 | (AISI410) drill screw ZB,BK/KK 4.2 x 13 mm. (To fix the top cover to the cover support and bracket 4217 345-000 to the top cover) | | 100 |
| 4600 392-000 | (AISI410) drill screw ZB,BK/KK 4.2 x 25 mm. (To fix the cover extension to the guide). | | 100 |

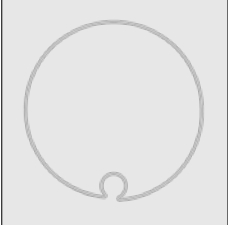
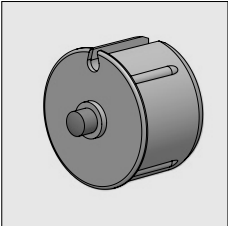

= Article will be sold out. Special orders remain possible.

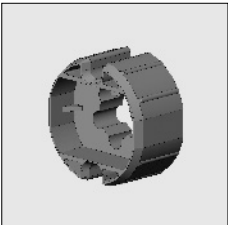
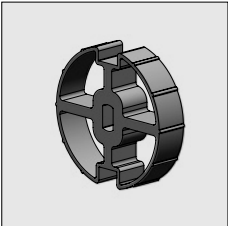
| Artikelnummer | Omschrijving | Uitvoering | Lengte in m ¹ Verp. eenh. |
|---|---|---------------------|---|
|  | 7700 952-006 Nylon sealing cap for drill screw 4,2 | White | 125 |
| | 7700 952-901 Idem | Cream | 125 |
| | 7700 952-716 Idem | Anthracite | 125 |
| | 7700 952-905 Idem | Black | 125 |
|  | 6253 382-000 Steel tube 85 x 1,25 mm with round groove (spec.) | zinc-plated | 4.0 |
| | 6253 384-000 Idem | zinc-plated | 4,5 |
| | 6253 386-000 Idem | zinc-plated | 5.0 |
| | 6253 390-000 Idem | zinc-plated | 6.0 |
| | 6253 392-000 Idem | zinc-plated | 6,5 |
| | 6253 394-000 Idem | zinc-plated | 7.0 |
| | 6253 396-000 Idem | zinc-plated | 7,5 |
| | 6253 382-008 Steel tube 85 x 1,25 mm with round groove (spec.) | RAL 7035 light grey | 4.0 |
| | 6253 384-008 Idem | RAL 7035 light grey | 4,5 |
| | 6253 386-008 Idem | RAL 7035 light grey | 5.0 |
| | 6253 390-008 Idem | RAL 7035 light grey | 6.0 |
| | 6253 392-008 Idem | RAL 7035 light grey | 6,5 |
| | 6253 394-008 Idem | RAL 7035 light grey | 7.0 |
| | 6253 396-008 Idem | RAL 7035 light grey | 7,5 |
|  | 4217 202-000 Nylon bearing roller bung 85 with axe 15 mm | | |
|  | 4217 205-000 Nylon washer spindle hole 16 mm for bearing roller bung 4217 202-000 | | 10 |
|  | 4000 951-000 Somfy friction ring for motor series 50/60 roller 85 | | |
|  | 4001 133-068 ASA friction ring for motor series 45/50 roller 85 | | |

= Article will be sold out. Special orders remain possible.

Pergola Awning Solidare®

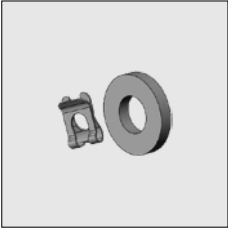
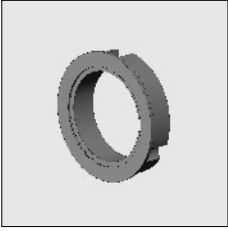
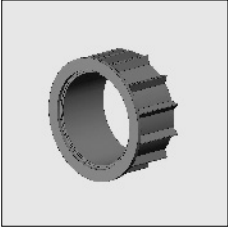
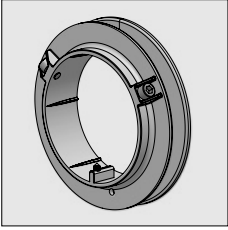
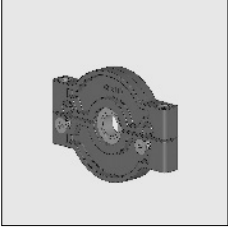
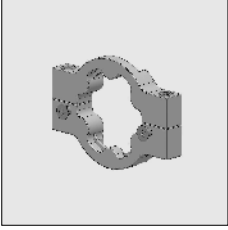
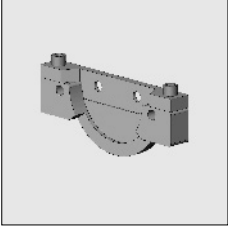
| Artikelnummer | Omschrijving | Uitvoering | Lengte in m ¹ Verp. eenh. |
|---|---|------------|---|
|  | 4001 106-068 ASA clamp spring kit (to fix friction ring 4001 133-068) | | |
|  | 4000 952-000 Somfy/ASA adaptor for motor series 60 roller 85 | | |
|  | 4000 953-000 Adaption ring Somfy/ASA motor series 50 roller 85 in combination with adapter 4000 952-000 | | |
|  | 4217 080-000 Nylon cord pulley roller 85 | | |
|  | 4215 114-068 Nylon bearing block incl. precision bearing | | |
|  | 4215 110-000 Alu motor bracket for Somfy (S)LT motors | | |
|  | 4215 111-000 Alu motor bracket for ASA motors | | |

= Article will be sold out. Special orders remain possible.

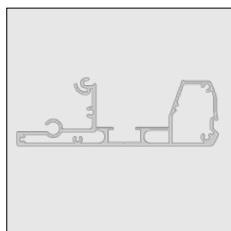

| Artikelnummer | Omschrijving | Uitvoering | Lengte in m ¹ Verp. eenh. |
|---------------|---|---------------------------|---|
| 6252 500-000 | Alu front profile Solidare | Mill finish | 4.0 |
| 6252 504-000 | Idem | Mill finish | 5.0 |
| 6295 508-000 | Idem | Mill finish | 6.0 |
| 6252 500-006 | Alu front profile Solidare | RAL 9010 pure white | 4.0 |
| 6252 504-006 | Idem | RAL 9010 pure white | 5.0 |
| 6252 508-006 | Idem | RAL 9010 pure white | 6.0 |
| 6252 500-901 | Alu front profile Solidare | RAL 9001 cream | 4.0 |
| 6252 504-901 | Idem | RAL 9001 cream | 5.0 |
| 6252 508-901 | Idem | RAL 9001 cream | 6.0 |
| 6252 500-755 | Alu front profile Solidare (* = Textured) | RAL 7016 anthracite grey* | 4.0 |
| 6252 504-755 | Idem (* = Textured) | RAL 7016 anthracite grey* | 5.0 |
| 6252 508-755 | Idem (* = Textured) | RAL 7016 anthracite grey* | 6.0 |

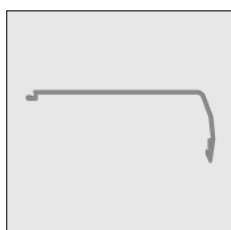

| | | | |
|--------------|---|---------------------------|-----|
| 6252 360-000 | Alu cover profile-front profile Solidare | Mill finish | 4.0 |
| 6252 364-000 | Idem | Mill finish | 5.0 |
| 6252 368-000 | Idem | Mill finish | 6.0 |
| 6252 360-006 | Alu cover profile-front profile Solidare | RAL 9010 pure white | 4.0 |
| 6252 364-006 | Idem | RAL 9010 pure white | 5.0 |
| 6252 368-006 | Idem | RAL 9010 pure white | 6.0 |
| 6252 360-901 | Alu cover profile-front profile Solidare | RAL 9001 cream | 4.0 |
| 6252 364-901 | Idem | RAL 9001 cream | 5.0 |
| 6252 368-901 | Idem | RAL 9001 cream | 6.0 |
| 6252 360-755 | Alu cover profile-front profile Solidare (* = Textured) | RAL 7016 anthracite grey* | 4.0 |
| 6252 364-755 | Idem (* = Textured) | RAL 7016 anthracite grey* | 5.0 |
| 6252 368-755 | Idem (* = Textured) | RAL 7016 anthracite grey* | 6.0 |

Tension wire system for front profile.

To prevent that the front profile will sag on larger widths, the tension wire system below can be applied and mounted below the front profile. To be used in combination all systems with front profiles. Cubola Piazzola, Piazzola pergola, Summerlight and Summerlight Verso. Take into account that the right distance brackets and support roller are used.



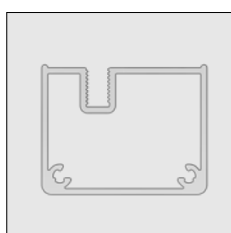

ATTENTION! The colors below are not available for every system.

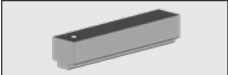
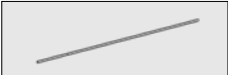
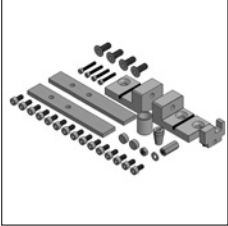
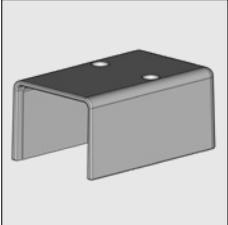
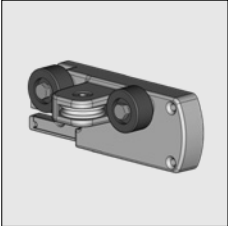

| | | | |
|--------------|--|---------------------------|-----|
| 6295 688-000 | Alu cover profile for tension wire system | Mill finish | 5.0 |
| 6295 690-000 | Idem | Mill finish | 6.0 |
| 6295 688-006 | Alu cover profile for tension wire system | RAL 9010 pure white | 5.0 |
| 6295 690-006 | Idem | RAL 9010 pure white | 6.0 |
| 6295 688-901 | Alu cover profile for tension wire system | RAL 9001 cream | 5.0 |
| 6295 690-901 | Idem | RAL 9001 cream | 6.0 |
| 6295 688-755 | Alu cover profile for tension wire system (* = Textured) | RAL 7016 anthracite grey* | 5.0 |
| 6295 690-755 | Idem (* = Textured) | RAL 7016 anthracite grey* | 6.0 |

= Article will be sold out. Special orders remain possible.

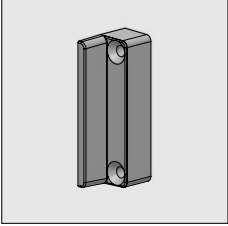
Pergola Awning Solidare®

| | Artikelnummer | Omschrijving | Uitvoering | Lengte in m ¹ Verp. eenh. |
|---|---------------|--|---------------------------|---|
|  | 4215 272-000 | Drilling template for tension wire system | | |
|  | 6295 695-000 | Stainless steel tension wire 304 | | 6,5 |
|  | 4215 256-068 | Parts kit with fixing materials for tension wire system | | |
|  | 4215 266-000 | Alu end cap for tension blocks | Mill finish | |
| | 4215 266-006 | Idem | RAL 9010 pure white | |
| | 4215 266-901 | Idem | RAL 9001 cream | |
| | 4215 266-755 | Idem (* = Textured) | RAL 7016 anthracite grey* | |
|  | 4217 326-090 | Alu guide pulley Solidare, left | Mill finish | |
| | 4217 328-090 | Idem, right | Mill finish | |
| | 4217 326-006 | Alu guide pulley Solidare, left | RAL 9010 pure white | |
| | 4217 328-006 | Idem, right | RAL 9010 pure white | |
| | 4217 326-901 | Alu guide pulley Solidare, left | RAL 9001 cream | |
| | 4217 328-901 | Idem, right | RAL 9001 cream | |
| | 4217 326-755 | Alu guide pulley Solidare, left (* = Textured) | RAL 7016 anthracite grey* | |
| | 4217 328-755 | Idem, right (* = Textured) | RAL 7016 anthracite grey* | |
|  | 4210 152-000 | Stainless steel plate screw countersunk Philips head 4.2 x 45 mm (to fix the guide pulley to the front profile) | | 100 |
|  | 4452 470-905 | Nylon end cap guide block upper side | Black | 10 |
|  | 4452 077-000 | Stainless steel plate screw countersunk Philips head 3.5 x 32 mm (to fix the end cap upper side to the guide block/front profile) | | 100 |

= Article will be sold out. Special orders remain possible.

| Artikelnummer | Omschrijving | Uitvoering | Lengte in m ¹ Verp. eenh. |
|---------------|--------------|------------|---|
|---------------|--------------|------------|---|



| | | | |
|--------------|---------------------------------------|-------|----|
| 4217 399-905 | Nylon end cap guide pulley upper part | Black | 10 |
|--------------|---------------------------------------|-------|----|



| | | | |
|--------------|---|--|-----|
| 4452 083-000 | Plate screw countersunk Philips head 3.5 x 16 mm (To fix the end cap upper part to the lower part) | | 100 |
|--------------|---|--|-----|

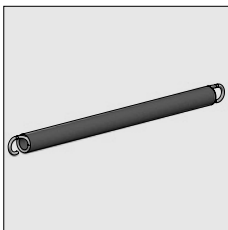

| | | | |
|--------------|--|--|--|
| 4215 183-000 | Stainless steel spring 25 mm, length 350 mm (for projection up to 350 cm) | | |
|--------------|--|--|--|

| | | | |
|--------------|---|--|--|
| 4215 185-000 | Stainless steel spring 25 mm, length 570 mm (for projection from 350 cm) | | |
|--------------|---|--|--|

Note: The springs are to be stretched up to a max. of 60% of the total spring length.

ATTENTION !!

The pretension must be approximately 30% of the total lengths of the springs.
The springs can be pretensioned when the front profile is close to the top cover.



| | | | |
|--------------|--|--|--|
| 4217 460-068 | Nylon support block for spring packet per 4 pieces (2 per spring) | | |
|--------------|--|--|--|

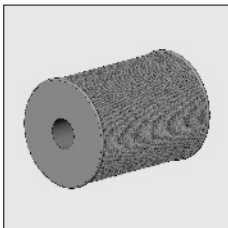

| | | | |
|--------------|-------------|-------|-----|
| 4215 155-000 | Cord 2,5 mm | White | 100 |
|--------------|-------------|-------|-----|



| | | | |
|--------------|--|--|----|
| 4215 158-000 | Stainless steel pulley for cord 2.5 mm with nylon runner | | 10 |
|--------------|--|--|----|

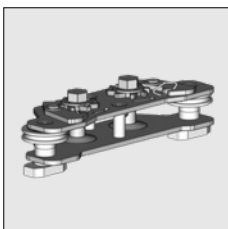

| | | | |
|--------------|-------------------------|--|--|
| 4215 022-068 | Cord tensioner Solidare | | |
|--------------|-------------------------|--|--|

ATTENTION !!

For this cord tensioner the runners are positioned higher than the similar cord tensioner of the Summerlight®.

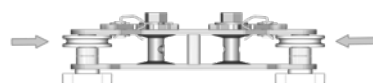

4215 022-068 cord tensioner Solidare

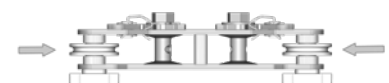

4215 020-068 cord tensioner Summerlight



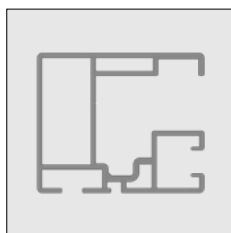

= Article will be sold out. Special orders remain possible.

Pergola Awning Solidare®



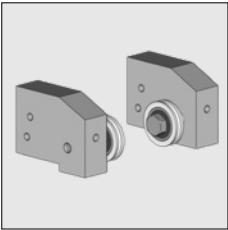
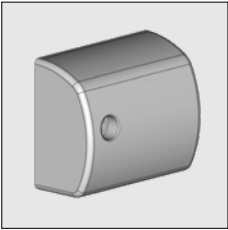
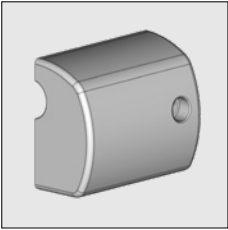

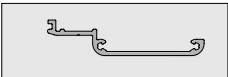

| Artikelnummer | Omschrijving | Uitvoering | Lengte in m ¹ Verp. eenh. |
|---------------|--|---------------------------|---|
| 6252 384-000 | Alu side guide Solidare | Mill finish | 5,0 |
| 6252 388-000 | Idem | Mill finish | 6,0 |
| 6252 394-000 | Idem | Mill finish | 7,5 |
| 6252 384-006 | Alu side guide Solidare | RAL 9010 pure white | 5,0 |
| 6252 388-006 | Idem | RAL 9010 pure white | 6,0 |
| 6252 394-006 | Idem | RAL 9010 pure white | 7,5 |
| 6252 384-901 | Alu side guide Solidare | RAL 9001 cream | 5,0 |
| 6252 388-901 | Idem | RAL 9001 cream | 6,0 |
| 6252 394-901 | Idem | RAL 9001 cream | 7,5 |
| 6252 384-755 | Alu side guide Solidare (* = Textured) | RAL 7016 anthracite grey* | 5,0 |
| 6252 388-755 | Idem | RAL 7016 anthracite grey* | 6,0 |
| 6252 394-755 | Idem | RAL 7016 anthracite grey* | 7,5 |
| 4090 054-000 | Stainless steel countersunk cross screw M 6 x 14 mm To fix the cover support and bearing block set to the side guide support) | | 100 |
| 4410 402-000 | Stainless steel Washer M6 | | 100 |
| 4452 481-008 | Nylon guide for side guide | Grey | 6,0 |
| 4452 485-008 | Idem | Grey | 7,0 |
| 4452 484-008 | Idem | Grey | 7,5 |
| 4452 486-008 | Nylon funnel for nylon guide | Grey | 50 |
| 4452 070-000 | Plate screw countersunk Philips head 2,9 x 19 mm (to fix the funnel on nylon guide) | | 100 |
| 4452 487-000 | Neoprene strip 10 x 4 x 60 mm self-adhesive Use a strip every ± 50 cm on the nylon guide. | | 135 |
| 4217 390-000 | Alu guide plate for side guide Solidare, left | Mill finish | |
| 4217 392-000 | Idem, right | Mill finish | |
| 4217 390-006 | Alu guide plate for side guide Solidare, left | RAL 9010 pure white | |
| 4217 392-006 | Idem, right | RAL 9010 pure white | |
| 4217 390-901 | Alu guide plate for side guide Solidare, left | RAL 9001 cream | |
| 4217 392-901 | Idem, right | RAL 9001 cream | |
| 4217 390-755 | Alu guide plate for side guide Solidare, left (* = Textured) | RAL 7016 anthracite grey* | |
| 4217 392-755 | Idem, right (* = Textured) | RAL 7016 anthracite grey* | |

= Article will be sold out. Special orders remain possible.



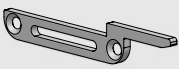

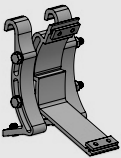
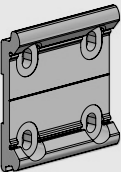
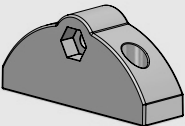
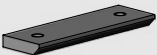

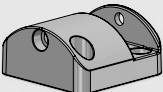
| Artikelnummer | Omschrijving | Uitvoering | Lengte in m ¹ Verp. eenh. |
|---|---|---------------------------|---|
|  | 4217 386-001 Alu bearing block Solidare | silver anodized | |
|  | 4217 395-000 Alu end cover left for bearing block 4217 386-001 | Mill finish | |
| | 4217 395-006 Idem | RAL 9010 pure white | |
| | 4217 395-901 Idem | RAL 9001 cream | |
| | 4217 395-755 Idem (* = Textured) | RAL 7016 anthracite grey* | |
|  | 4217 397-000 Alu end cover right for bearing block 4217 386-001 | Mill finish | |
| | 4217 397-006 Idem | RAL 9010 pure white | |
| | 4217 397-901 Idem | RAL 9001 cream | |
| | 4217 397-755 Idem (* = Textured) | RAL 7016 anthracite grey* | |
|  | 4217 185-000 Socket-head bolt M 6 x 16 mm cylinder head (To fix end cover to the end bearing) | | 50 |
|  | 6252 212-000 Alu gutter to match side guide Piazzola/Solidare | Mill finish | 4.0 |
| | 6252 214-000 Idem | Mill finish | 5.0 |
| | 6252 210-000 Idem | Mill finish | 6.0 |
| | 6252 212-006 Alu gutter to match side guide Piazzola/Solidare | RAL 9010 pure white | 4.0 |
| | 6252 214-006 Idem | RAL 9010 pure white | 5.0 |
| | 6252 210-006 Idem | RAL 9010 pure white | 6.0 |
| | 6252 212-901 Alu gutter to match side guide Piazzola/Solidare | RAL 9001 cream | 4.0 |
| | 6252 214-901 Idem | RAL 9001 cream | 5.0 |
| | 6252 210-901 Idem | RAL 9001 cream | 6.0 |
| | 6252 212-755 Alu gutter to match side guide Piazzola/Solidare (* = Textured) | RAL 7016 anthracite grey* | 4.0 |
| | 6252 214-755 Idem | RAL 7016 anthracite grey* | 5.0 |
| | 6252 210-755 Idem | RAL 7016 anthracite grey* | 6.0 |
|  | 4217 190-000 Stainless steel drill screw cylinder/Philips head 4.2 x 13 mm (to fix the gutter to the side guide) | | 100 |

= Article will be sold out. Special orders remain possible.

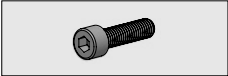
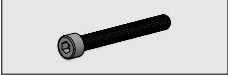
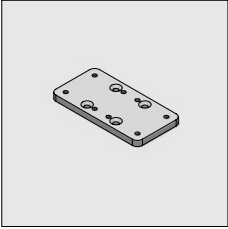
Pergola Awning Solidare®

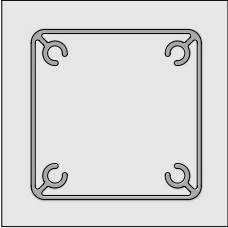
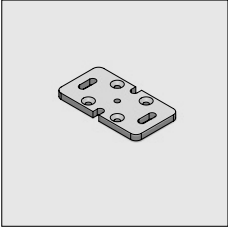

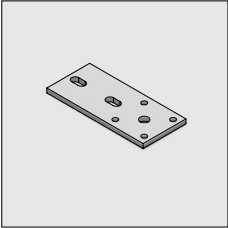

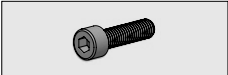
| | Artikelnummer | Omschrijving | Uitvoering | Lengte in m ¹ Verp. eenh. |
|---|---------------|--|---------------------------|---|
|  | 7700 952-006 | Nylon sealing cap for round head screw 4.2 mm | White | 125 |
| | 7700 952-901 | Idem | RAL 9001 cream | 125 |
| | 7700 952-716 | Idem | Anthracite grey | 125 |
| | 7700 952-905 | Idem | Black | 125 |
|  | 4217 045-000 | Alu end cap for gutter Piazzola/Solidare | Mill finish | |
| | 4217 045-006 | Idem | RAL 9010 pure white | |
| | 4217 045-901 | Idem | RAL 9001 cream | |
| | 4217 045-755 | Idem (* = Textured) | RAL 7016 anthracite grey* | |
|  | 4452 083-000 | Stainless steel countersunk/Philips head 3.5 x 16 mm (to fix the end cap to the gutter) | | 100 |
|  | 4217 120-090 | Alu mounting bracket Piazzola/Solidare | Mill finish | |
| | 4217 120-006 | Idem | RAL 9010 pure white | |
| | 4217 120-901 | Idem | RAL 9001 cream | |
| | 4217 120-755 | Idem (* = Textured) | RAL 7016 anthracite grey* | |
|  | 4211 772-090 | Alu fastening plate 140 mm Piazzola/Gota/Solidare | Mill finish | |
| | 4211 772-006 | Idem | RAL 9010 pure white | |
| | 4211 772-901 | Idem | RAL 9001 cream | |
| | 4211 772-755 | Idem (* = Textured) | RAL 7016 anthracite grey* | |
|  | 4217 000-000 | Alu upper hinge part | Mill finish | |
| | 4217 000-006 | Idem | RAL 9010 pure white | |
| | 4217 000-901 | Idem | RAL 9001 cream | |
| | 4217 000-755 | Idem (* = Textured) | RAL 7016 anthracite grey* | |
|  | 4217 070-000 | Stainless steel clamping plate for upper hinge part | | |
|  | 4410 238-000 | Stainless steel socket-head bolt M6 x 20 mm Philips cylinder head (to fix the hinge part) | | 100 |
|  | 4217 005-000 | Alu lower hinge part | Mill finish | |
| | 4217 005-006 | Idem | RAL 9010 pure white | |
| | 4217 005-901 | Idem | RAL 9001 cream | |
| | 4217 005-755 | Idem (* = Textured) | RAL 7016 anthracite grey* | |

= Article will be sold out. Special orders remain possible.

| Artikelnummer | Omschrijving | Uitvoering | Lengte in m ¹ Verp. eenh. |
|---|--|---------------------------|---|
|  | 4410 400-000 Stainless steel socket-head bolt M8 x 30 mm Philips cylinder head (to fix the lower hinge part to the leg. Makes threaded end in leg) | | 50 |
|  | 4217 175-000 Stainless steel socket-head bolt M8 x 70 mm Philips cylinder head (to fix upper hinge part to the lower hinge part) | | 25 |
| For coupled Piazzola/Solidare the 2 side guides can be mounted in the middle on 1 leg by the couple plate below. | | | |
|  | 4217 020-090 Alu couple plate for 2 hinge parts under the Piazzola | Mill finish | |
| | 4217 020-006 Idem | RAL 9010 pure white | |
| | 4217 020-901 Idem | RAL 9001 cream | |
| | 4217 020-755 Idem (* = Textured) | RAL 7016 anthracite grey* | |
|  | 4217 180-000 Stainless steel socket-head bolt M 8 x 16 mm Philips cylinder head (to fix the hinge part under to the couple plate) | | 50 |
|  | 6252 170-000 Alu leg Piazzola/Solidare | Mill finish | 6.0 |
| | 6252 170-006 Idem | RAL 9010 pure white | 6.0 |
| | 6252 170-901 Idem | RAL 9001 cream | 6.0 |
| | 6252 170-755 Idem (* = Textured) | RAL 7016 anthracite grey* | 6.0 |
|  | 4217 015-090 Alu base plate Piazzola | Mill finish | |
| | 4217 015-006 Idem | RAL 9010 pure white | |
| | 4217 015-901 Idem | RAL 9001 cream | |
| | 4217 015-755 Idem (* = Textured) | RAL 7016 anthracite grey* | |
|  | 4210 063-000 Stainless steel socket-head bolt M8 x 30 mm countersunk Philips head (to fix the couple plate and the base plate to the leg. Makes threaded end in leg) | | 50 |
|  | 4217 145-000 Steel base plate Piazzola. To be used in combination with a concrete base | Zinc-plated | |
|  | 4210 529-000 Stainless steel washer M8 | | 100 |
|  | 4410 400-000 Stainless steel socket-head bolt M8 x 30 mm Philips cylinder head (to fix the base plate to the leg. Makes threaded end in leg) | | 100 |

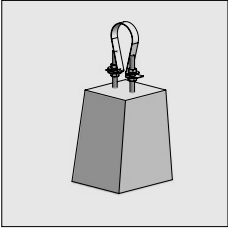
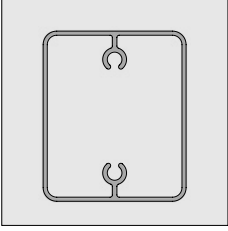
= Article will be sold out. Special orders remain possible.

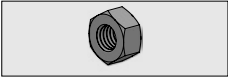
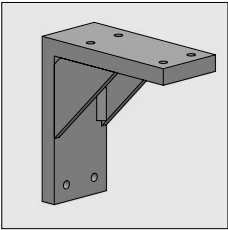
Pergola Awning Solidare®

| Artikelnummer | Omschrijving | Uitvoering | Lengte in m ¹ Verp. eenh. |
|---|---|---------------------------|---|
|  | 7700 317-068 Concrete base 20 x 17.5 x 25 cm | | |
|  | 6252 184-000 Alu support beam Piazzola/Solidare | Mill finish | 5.0 |
| | 6252 180-000 Idem | Mill finish | 6.0 |
| | 6252 182-000 Idem | Mill finish | 7.0 |
| | 6252 184-006 Alu support beam Piazzola/Solidare | RAL 9010 pure white | 5.0 |
| | 6252 180-006 Idem | RAL 9010 pure white | 6.0 |
| | 6252 182-006 Idem | RAL 9010 pure white | 7.0 |
| | 6252 184-901 Alu support beam Piazzola/Solidare | RAL 9001 cream | 5.0 |
| | 6252 180-901 Idem | RAL 9001 cream | 6.0 |
| | 6252 182-901 Idem | RAL 9001 cream | 7.0 |
| | 6252 184-755 Alu support beam Piazzola/Solidare (* = Textured) | RAL 7016 anthracite grey* | 5.0 |
| | 6252 180-755 Idem | RAL 7016 anthracite grey* | 6.0 |
| | 6252 182-755 Idem | RAL 7016 anthracite grey* | 7.0 |
|  | 4217 280-000 Stainless steel hexagon bolt M8 x 50 mm (to fix the support beam to the leg. Makes threaded end in support beam) | | 50 |
|  | 4210 529-000 Stainless steel washer M8 | | 100 |
|  | 4000 226-000 Hexagon nut M8 stainless | | 50 |
|  | 4217 165-001 Alu reinforcement angle Piazzola | Silver anodized | |
|  | 4600 392-000 Stainless steel (AISI 410) drill screw Philips cylinder Philips head 4.2 x 25 mm (to fix the angle to the leg/support beam) | | 100 |

= Article will be sold out. Special orders remain possible.

| Artikelnummer | Omschrijving | Uitvoering | Lengte in m ¹ Verp. eenh. |
|---------------|--------------|------------|---|
|---------------|--------------|------------|---|

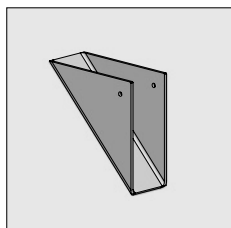

| | | | |
|--------------|--|---------------------------|--|
| 4217 170-000 | Alu end cap for reinforcement angle Piazzola | Mill finish | |
| 4217 170-006 | Idem | RAL 9010 pure white | |
| 4217 170-901 | Idem | RAL 9001 cream | |
| 4217 170-755 | Idem (* = Textured) | RAL 7016 anthracite grey* | |

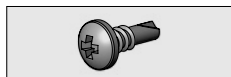

| | | | |
|--------------|---|--|-----|
| 7700 306-000 | (AISI 410) round head screw cylinder Philips head 4.2 x 13 mm (to fix the end cap to the reinforcement angle) | | 100 |
|--------------|---|--|-----|



| | | | |
|--------------|--|------------|-----|
| 7700 952-006 | Nylon sealing cap for round head screw 4,2 | white | 125 |
| 7700 952-901 | Idem | cream | 125 |
| 7700 952-716 | Idem | anthracite | 125 |
| 7700 952-905 | Idem | black | 125 |

In case of large projections the support beams (6252180/182/184) can be mounted under the side guides, as support for the fabric. When the tension wire system is mounted under the front profile, fix the brackets 130 mm to the support beams.

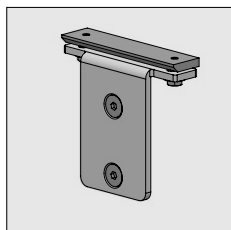

| | | | |
|--------------|---------------------|---------------------------|--|
| 4217 152-090 | Alu bracket 95 | Mill finish | |
| 4217 152-006 | Idem | RAL 9010 pure white | |
| 4217 152-901 | Idem | RAL 9001 cream | |
| 4217 152-755 | Idem (* = Textured) | RAL 7016 anthracite grey* | |

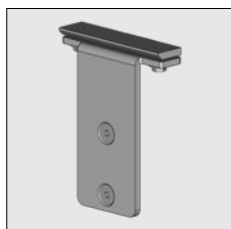

| | | | |
|--------------|---------------------|---------------------------|--|
| 4217 154-090 | Alu bracket 130 | Mill finish | |
| 4217 154-006 | Idem | RAL 9010 pure white | |
| 4217 154-901 | Idem | RAL 9001 cream | |
| 4217 154-755 | Idem (* = Textured) | RAL 7016 anthracite grey* | |

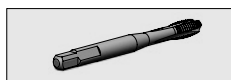

| | | | |
|--------------|--|-----------------|--|
| 4217 240-000 | Spiral flute tap M8, makes thread end in leg and in support beam | Silver anodized | |
|--------------|--|-----------------|--|

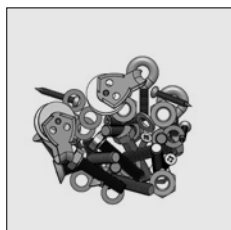

| | | | |
|--------------|---|--|--|
| 4217 340-068 | Solidare fixing kit with materials, 2x pulleys and 2x screw eye | | |
|--------------|---|--|--|

= Article will be sold out. Special orders remain possible.

Pergola Awning Solidare®

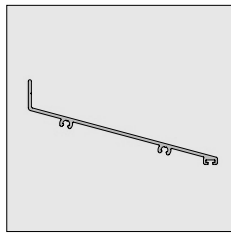

| Artikelnummer | Omschrijving | Uitvoering | Lengte in m ¹ Verp. eenh. |
|---------------|---|---------------------------|---|
| 6252 234-000 | Alu wall cover Piazzola/Solidare | Mill finish | 5.0 |
| 6252 230-000 | Idem | Mill finish | 6.0 |
| 6252 232-000 | # Idem | Mill finish | 7.0 |
| 6252 234-006 | Alu wall cover Piazzola/Solidare | RAL 9010 pure white | 5.0 |
| 6252 230-006 | Idem | RAL 9010 pure white | 6.0 |
| 6252 232-006 | # Idem | RAL 9010 pure white | 7.0 |
| 6252 234-901 | Alu wall cover Piazzola/Solidare | RAL 9001 cream | 5.0 |
| 6252 230-901 | Idem | RAL 9001 cream | 6.0 |
| 6252 234-755 | Alu wall cover Piazzola/Solidare (* = Textured) | RAL 7016 anthracite grey* | 5.0 |
| 6252 230-755 | Idem | RAL 7016 anthracite grey* | 6.0 |
| 6252 232-755 | # Idem | RAL 7016 anthracite grey* | 7.0 |

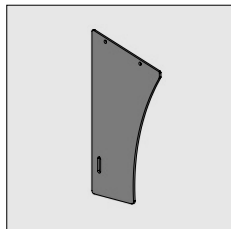

| | | | |
|--------------|---------------------------------------|---------------------------|--|
| 4217 075-000 | Alu end plate for wall cover Piazzola | Mill finish | |
| 4217 075-006 | Idem | RAL 9010 pure white | |
| 4217 075-901 | Idem | RAL 9001 cream | |
| 4217 075-755 | Idem (* = Textured) | RAL 7016 anthracite grey* | |



| | | | |
|--------------|---|--|-----|
| 4210 141-000 | Stainless steel round head cylinder/cross screw 4.2 x 22 mm (to fix end plate to wall cover) | | 100 |
|--------------|---|--|-----|



| | | | |
|--------------|---|------------|-----|
| 7700 952-006 | Nylon sealing cap for round head screw 4.2 mm | White | 125 |
| 7700 952-901 | Idem | Cream | 125 |
| 7700 952-716 | Idem | Anthracite | 125 |
| 7700 952-905 | Idem | Black | 125 |

= Article will be sold out. Special orders remain possible.