

Freestanding Awning Cubola® Summerlight®



7

The Cubola® is a patented product.
All necessary items for this product must be purchased from the AVZ-Group.
For any exceptions or further questions, please contact our sales department.



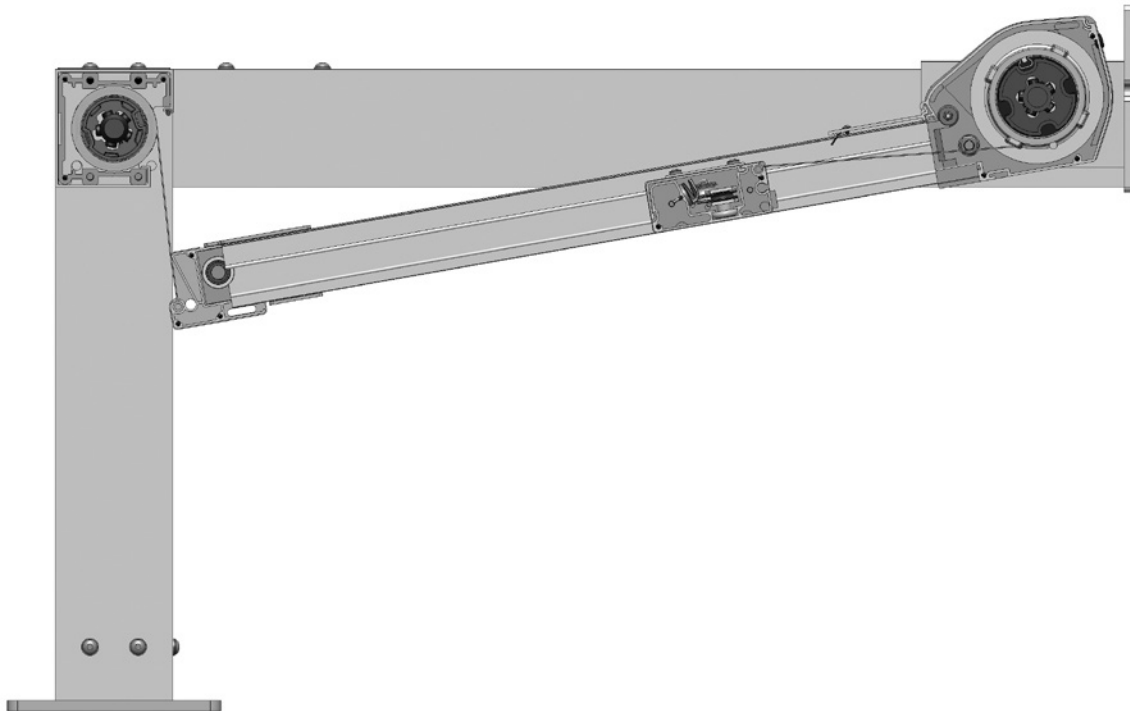
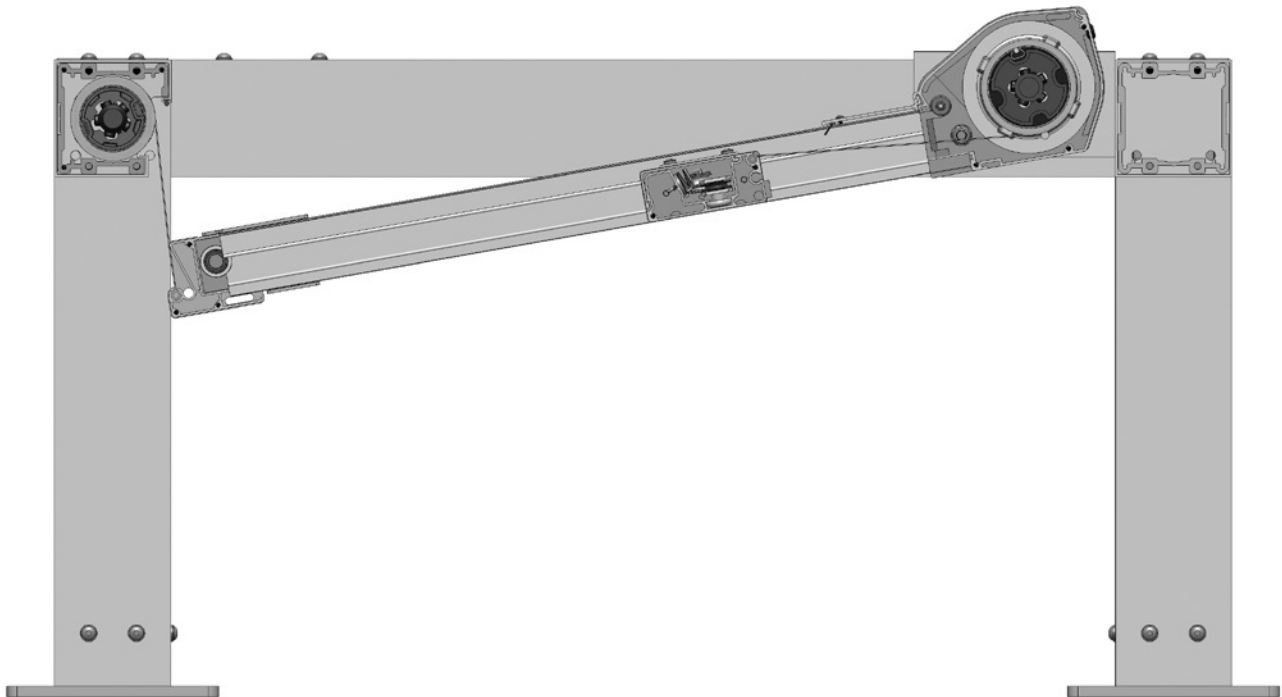

Freestanding Awning Cubola® Summerlight®



7

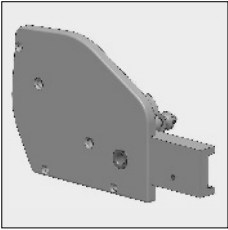
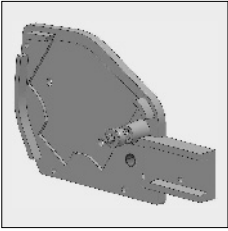
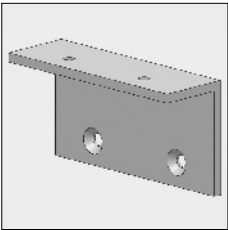
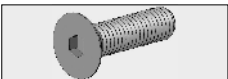

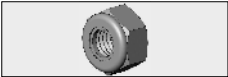
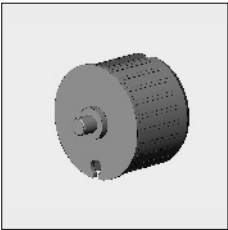

The Cubola® is a patented product.
All necessary items for this product must be purchased from the AVZ-Group.
For any exceptions or further questions, please contact our sales department.

Freestanding Awning Cubola® Summerlight®

Part number	Description	Paint finish	Length in m ¹ Pack. Unit
	4409 960-090 Alu end fix bracket Cubola, left	Mill finish	
	4409 960-006 Idem	RAL 9010 pure white	
	4409 960-755 Idem (* = Textured)	RAL 7016 anthracite grey*	
	4409 962-090 Alu end fix bracket Cubola, right	Mill finish	
	4409 962-006 Idem	RAL 9010 pure white	
	4409 962-755 Idem (* = Textured)	RAL 7016 anthracite grey*	
	4409 964-090 Alu corner Cubola for fixing the end fix bracket to the support beam	Mill finish	
	4409 964-006 Idem	RAL 9010 pure white	
	4409 964-755 Idem (* = Textured)	RAL 7016 anthracite grey*	
	4210 026-000 Stainless steel socket-head bolt M10 x 35 mm with countersunk Philips head (for fixing the corner to the end fix bracket)		50
	4210 482-000 Stainless steel washer M10		100
	4210 155-000 Stainless steel lock nut M10		100
	4470 082-000 Nylon bearing roller bung 78 with spindle 12 x 12 mm, flange 5 mm	Grey	10
	4460 020-080 Nylon adjusting bush 15 to 12 mm (for precision bearing)		100
	4210 497-000 Nylon washer 20 x 12 x 2 mm		50

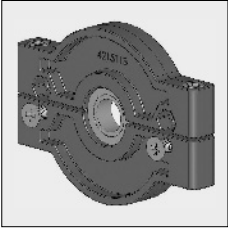
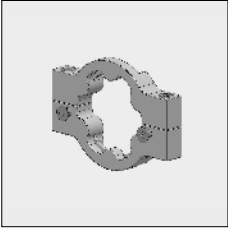
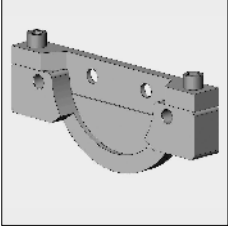
= Article will be sold out. Special orders remain possible.

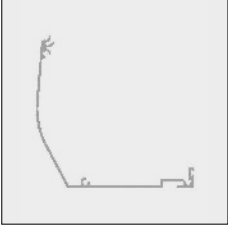
Freestanding Awning Cubola® Summerlight®

Part number	Description	Paint finish	Length in m ¹ Pack. Unit
	4215 114-068 Nylon bearing block incl. precision bearing		
	4215 110-000 Alu motor bracket for Somfy (S)LT motors		
	4215 111-000 Alu motor bracket for ASA motors		
	4215 123-000 Nylon cord pulley		
	6295 610-000 Alu rear/bottom cover Cubola Summerlight	Mill finish	4.0
	6295 614-000 Idem	Mill finish	5.0
	6295 618-000 Idem	Mill finish	6.0
	6295 620-000 Idem	Mill finish	7.0
	6295 610-006 Alu rear/bottom cover Cubola Summerlight	RAL 9010 pure white	4.0
	6295 614-006 Idem	RAL 9010 pure white	5.0
	6295 618-006 Idem	RAL 9010 pure white	6.0
	6295 620-006 # Idem	RAL 9010 pure white	7.0
	6295 610-755 Alu rear/bottom cover Cubola Summerlight (* = Textured)	RAL 7016 anthracite grey*	4.0
	6295 618-755 Idem (* = Textured)	RAL 7016 anthracite grey*	6.0
	4210 142-000 Plate screw with countersunk Philips head 4.2 x 32 mm (for fixing the rear/bottom cover to the end fix bracket)		100
	4211 130-080 Nylon insert strip for stopper in rear/bottom cover	Black	50
	4211 132-080 Idem	White	50

= Article will be sold out. Special orders remain possible.

Freestanding Awning Cubola® Summerlight®

Part number	Description	Paint finish	Length in m ¹ Pack. Unit
6295 662-000	Alu top cover suitable to be used with cover extension	Mill finish	4.0
6295 666-000	Idem	Mill finish	5.0
6295 668-000	Idem	Mill finish	6.0
6295 670-000	Idem	Mill finish	7.0
6295 662-006	Alu top cover suitable to be used with cover extension	RAL 9010 pure white	4.0
6295 666-006	Idem	RAL 9010 pure white	5.0
6295 668-006	Idem	RAL 9010 pure white	6.0
6295 670-006	Idem	RAL 9010 pure white	7.0
6295 662-755	Alu top cover suitable to be used with cover extension (* = Textured)	RAL 7016 anthracite grey*	4.0
6295 668-755	Idem (* = Textured)	RAL 7016 anthracite grey*	6.0
6295 980-000	Alu cover extension	Mill finish	4.0
6295 984-000	Idem	Mill finish	5.0
6295 988-000	Idem	Mill finish	6.0
6295 980-006	Alu cover extension	RAL 9010 pure white	4.0
6295 984-006	Idem	RAL 9010 pure white	5.0
6295 988-006	Idem	RAL 9010 pure white	6.0
6295 980-755	Alu cover extension (* = Textured)	RAL 7016 anthracite grey*	4.0
6295 984-755	Idem (* = Textured)	RAL 7016 anthracite grey*	5.0
6295 988-755	Idem (* = Textured)	RAL 7016 anthracite grey*	6.0
4215 190-080	Bristle to be used in cover extension	Black	25
4215 190-000	Idem	Black	500
6295 553-000	Alu side guide Cubola 60 x 75 mm	Mill finish	6.0
6295 553-006	Idem	RAL 9010 pure white	6.0
6295 553-755	Idem (* = textured)	RAL 7016 anthracite grey*	6.0
6295 554-000	Alu side guide Cubola 60 x 75 mm	Mill finish	7.5
6295 554-006	Idem	RAL 9010 pure white	7.5
6295 554-755	Idem (* = textured)	RAL 7016 anthracite grey*	7.5
4215 124-000	Alu guide plate	Mill finish	
4215 124-006	Idem	RAL 9010 pure white	
4215 124-755	Idem (* = textured)	RAL 7016 anthracite grey*	

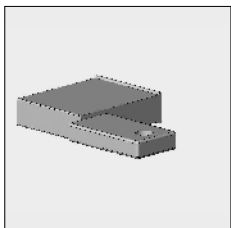
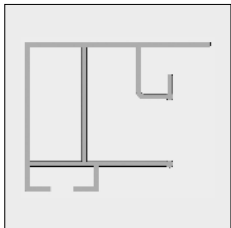
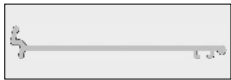
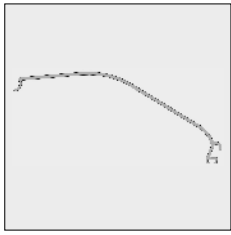

= Article will be sold out. Special orders remain possible.



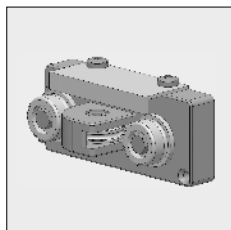
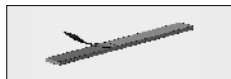
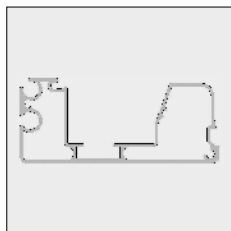
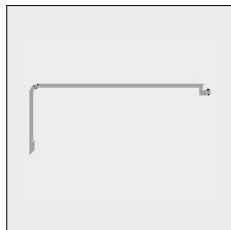
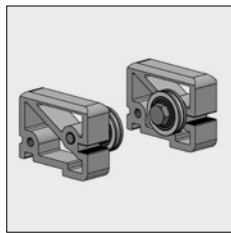

Freestanding Awning Cubola® Summerlight®

Part number	Description	Paint finish	Length in m ¹ Pack. Unit
4217 260-001	Kit end bearings for guide Cubola	Anodized	
6295 562-000	Alu front profile (upper part)	Mill finish	4.0
6295 565-000	Idem	Mill finish	5.0
6295 566-000	Idem	Mill finish	6.0
6295 568-000	Idem	Mill finish	7,0
6295 562-006	Alu front profile (upper part)	RAL 9010 pure white	4.0
6295 565-006	Idem	RAL 9010 pure white	5.0
6295 566-006	Idem	RAL 9010 pure white	6.0
6295 568-006	Idem	RAL 9010 pure white	7,0
6295 562-755	Alu front profile (upper part) (* = textured)	RAL 7016 anthracite grey*	4.0
6295 565-755	Idem (* = textured)	RAL 7016 anthracite grey*	5.0
6295 566-755	Idem (* = textured)	RAL 7016 anthracite grey*	6.0
6295 572-000	Alu front profile (lower part)	Mill finish	4.0
6295 575-000	Idem	Mill finish	5.0
6295 576-000	Idem	Mill finish	6.0
6295 578-000	Idem	Mill finish	7,0
6295 572-006	Alu front profile (lower part)	RAL 9010 pure white	4.0
6295 575-006	Idem	RAL 9010 pure white	5.0
6295 576-006	Idem	RAL 9010 pure white	6.0
6295 578-006	Idem	RAL 9010 pure white	7,0
6295 572-755	Alu front profile (lower part) (* = textured)	RAL 7016 anthracite grey*	4.0
6295 575-755	Idem (* = textured)	RAL 7016 anthracite grey*	5.0
6295 576-755	Idem (* = textured)	RAL 7016 anthracite grey*	6.0
4452 238-000	Neoprene strip 10 x 2 mm, self-adhesive, for suppression of impact sound and for a correct fitting of the upper and lower front profiles		50
Note: use a strip of ± 10 cm per every ± 100 cm awning width.			
4215 310-090	Alu guide pulley, left	Mill finish	
4215 312-090	Idem, right	Mill finish	
4215 310-006	Alu guide pulley, left	RAL 9010 pure white	
4215 312-006	Idem, right	RAL 9010 pure white	
4215 310-755	Alu guide pulley, left (* = textured)	RAL 7016 anthracite grey*	
4215 312-755	Idem, right (* = textured)	RAL 7016 anthracite grey*	



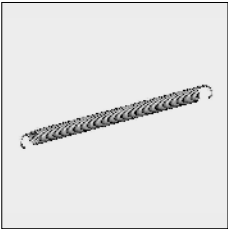
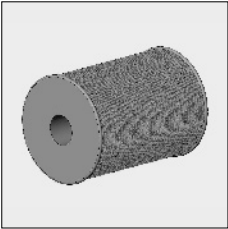

= Article will be sold out. Special orders remain possible.

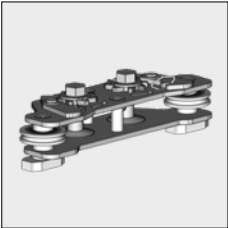
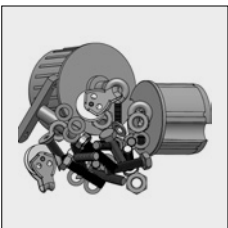
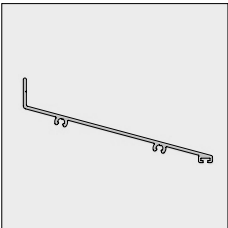
Freestanding Awning Cubola® Summerlight®

Part number	Description	Paint finish	Length in m ¹ Pack. Unit
	4210 142-000 Plate screw with countersunk Philips head 4.2 x 32 mm (for fixing the guide block to the pulling frame)		100
	4215 172-068 Screw eye with nut M 6 for fixing the spring to the guide block		10
	4215 183-000 Stainless steel spring 25 mm, length 350 mm (for a projection up to 350 cm)		
	4215 185-000 Idem, length 570 mm (for a projection from 350 cm)		
Note: the springs are to be stretched up to a maximum of 60% of the total spring length.			
ATTENTION !! The pretention must be approximately 30% of the total lengths of the springs. The springs can be pretensioned when the front profile is close to the top cover.			
	4215 155-000 Cord 2,5 mm	White	100
	4215 158-000 Stainless steel pulley for cord 2,5 mm with nylon runner		10
	4215 020-068 Cord tensioner Summerlight		
	4409 932-068 Cubola kit with fixing materials, bearing pin, bearing roller bung, bus 12/15, 2x pulleys en 2x screw eye. For 1 freestanding Cubola.		
The following wall cover can be used for a wall mounted version:			
	6252 234-000 Alu wall cover Cubola/Piazzola	Mill finish	5.0
	6252 230-000 Idem	Mill finish	6.0
	6252 232-000 # Idem	Mill finish	7.0
	6252 234-006 Alu wall cover Cubola/Piazzola	RAL 9010 pure white	5.0
	6252 230-006 Idem	RAL 9010 pure white	6.0
	6252 232-006 # Idem	RAL 9010 pure white	7.0

= Article will be sold out. Special orders remain possible.

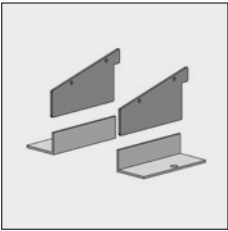
Freestanding Awning Cubola® Summerlight®

Part number	Description	Paint finish	Length in m ¹ Pack. Unit
6252 234-755	Alu wall cover Cubola/Piazzola (*= Textured)	RAL 7016 anthracite grey*	5.0
6252 230-755	Idem	RAL 7016 anthracite grey*	6.0
6252 232-755 #	Idem	RAL 7016 anthracite grey*	7,0
	4211 130-080 Nylon insert strip for wall cover	Black	50
	4211 132-080 Idem	White	50
	4409 939-090 Alu side plate kit wall cover Cubola	Mill finish	
	4409 939-006 Idem	RAL 9010 pure white	
	4409 939-755 Idem (* = Textured)	RAL 7016 anthracite grey*	
	4210 141-000 Plate screw with countersunk Philips head 4.2 x 32 mm (for fixing the side plate to the wall cover)		100
	7700 952-006 Nylon sealing cap for drill screw 4.2 mm	White	125
	7700 952-901 Idem	Cream	125
	7700 952-716 Idem	Anthracite	125
	7700 952-905 Idem	Black	125

Further requirements:
 - Rollers 63, 78 and 85 refer to chapter 1

= Article will be sold out. Special orders remain possible.