

Conservatory awning Solidare® Verso

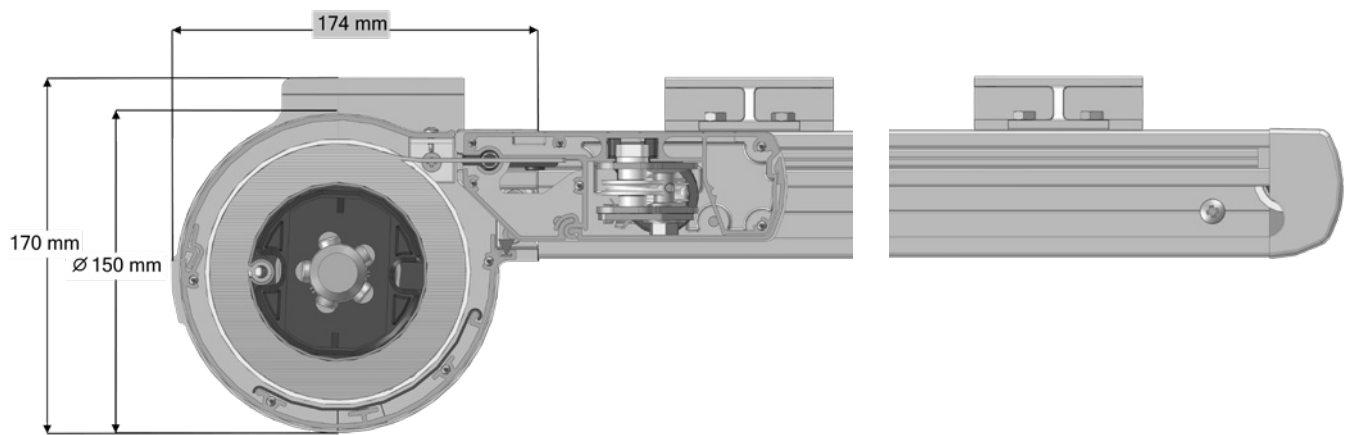

7

Conservatory awning Solidare® Verso

Part number	Description	Paint finish	Length in m ¹ Pack. Unit
4217 437-090	Alu top cover support set Solidare Verso	Mill finish	
4217 437-006	Idem	RAL 9010 pure white	
4217 437-901	Idem	RAL 9001 cream	
4217 437-755	Idem (* = Textured)	RAL 7016 anthracite grey*	

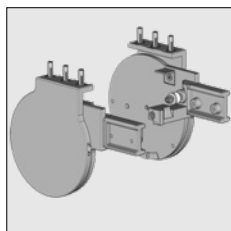

To fasten to a patio awning, one needs a rivet nut tool.

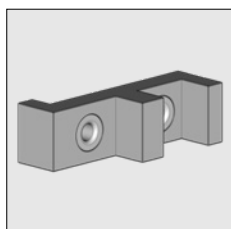

4217 310-000 Drilling template piece for side guide
(to fasten the top cover support to the side guide)

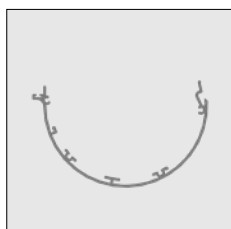

6252 440-000	Alu bottom cover Solidare Verso	Mill finish	4.0
6252 444-000	Idem	Mill finish	5.0
6252 448-000	Idem	Mill finish	6.0
6252 440-006	Alu bottom cover Solidare Verso	RAL 9010 pure white	4.0
6252 444-006	Idem	RAL 9010 pure white	5.0
6252 448-006	Idem	RAL 9010 pure white	6.0
6252 440-901	Alu bottom cover Solidare Verso	RAL 9001 cream	4.0
6252 444-901	Idem	RAL 9001 cream	5.0
6252 448-901	Idem	RAL 9001 cream	6.0
6252 440-755	Alu bottom cover Solidare Verso (* = Textured)	RAL 7016 anthracite grey*	4.0
6252 444-755	Idem	RAL 7016 anthracite grey*	5.0
6252 448-755	Idem	RAL 7016 anthracite grey*	6.0

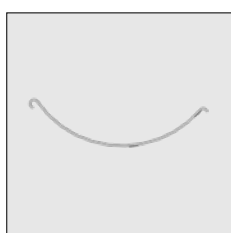

4217 490-000 Nylon roller support Solidare Verso 5.0





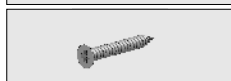

4452 276-000 Bristle 8 mm for bottom cover Grey 100



4210 142-000 Plate screw countersunk Philips head 4.2 x 32 mm
(to fix the bottom cover to the top cover support) 100

= Article will be sold out. Special orders remain possible.

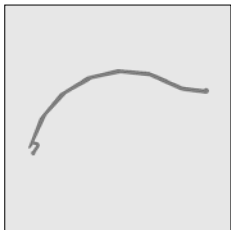
Conservatory awning Solidare® Verso

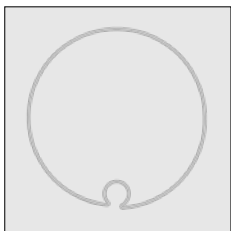
Part number	Description	Paint finish	Length in m ¹ Pack. Unit
	4217 495-000	Center bracket for bottom cover Solidare Verso. Apply upward of ca. 4,5 m. width	Mill finish
	4217 495-006	Idem	RAL 9010 pure white
	4217 495-901	Idem	RAL 9001 cream
	4217 495-755	Idem (* = Textured)	RAL 7016 anthracite grey*
	4600 392-000	(AISI410) drill screw ZB.BK/KK 4,2 x 25 mm. To fix the center bracket to the support beam of the patio roof.	100
	6252 420-000	Alu top cover Solidare Verso	Mill finish 4.0
	6252 424-000	Idem	Mill finish 5.0
	6252 428-000	Idem	Mill finish 6.0
	6252 420-006	Alu top cover Solidare Verso	RAL 9010 pure white 4.0
	6252 424-006	Idem	RAL 9010 pure white 5.0
	6252 428-006	Idem	RAL 9010 pure white 6.0
	6252 420-901	Alu top cover Solidare Verso	RAL 9001 cream 4.0
	6252 424-901	Idem	RAL 9001 cream 5.0
	6252 428-901	Idem	RAL 9001 cream 6.0
	6252 420-755	Alu top cover Solidare Verso (* = Textured)	RAL 7016 anthracite grey* 4.0
	6252 424-755	Idem	RAL 7016 anthracite grey* 5.0
	6252 428-755	Idem	RAL 7016 anthracite grey* 6.0
	4452 097-000	(AISI410) drill screw ZB.BK/KK 3.5 x 9.5 mm. To fix the top cover to the top cover support.	100
	6253 382-000	Steel roller 85 x 1.25 mm with round groove (spec.)	Zinc-plated 4.0
	6253 384-000	Idem	Zinc-plated 4,5
	6253 386-000	Idem	Zinc-plated 5.0
	6253 390-000	Idem	Zinc-plated 6.0
	6253 392-000	Idem	Zinc-plated 6,5
	6253 394-000	Idem	Zinc-plated 7,0
	6253 396-000	Idem	Zinc-plated 7.5
	6253 382-008	Steel roller 85 x 1,25 mm with round groove (spec.)	RAL 7035 light grey 4.0
	6253 384-008	Idem	RAL 7035 light grey 4,5
	6253 386-008	Idem	RAL 7035 light grey 5.0
	6253 390-008	Idem	RAL 7035 light grey 6.0
	6253 392-008	Idem	RAL 7035 light grey 6.5
	6253 394-008	Idem	RAL 7035 light grey 7.0
	6253 396-008	Idem	RAL 7035 light grey 7.5

= Article will be sold out. Special orders remain possible.

Conservatory awning Solidare® Verso

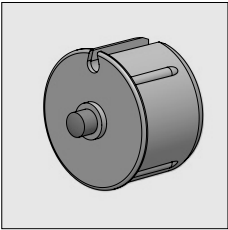
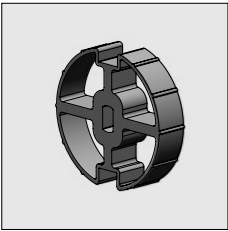
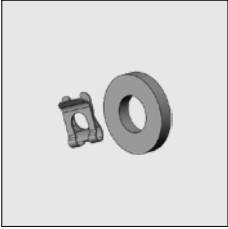
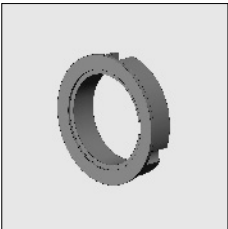
Part number	Description	Paint finish	Length in m ¹ Pack. Unit
4217 202-000	Nylon bearing roller bung 85 with spindle 15 mm		
			
4217 205-000	Nylon washer spindle hole 16 mm for bearing roller bung 4217 202-000		10
			
4000 951-000	Somfy friction ring for motor series 50/60 roller 85		
			
4001 133-068	ASA friction ring for motor series 45/50 roller 85		
			
4001 106-068	ASA clamp spring kit (to fix friction ring 4001 133-068)		
			
4000 952-000	Somfy/ASA adapter for motor series 60 roller 85		
			
4000 953-000	Adaption ring Somfy/ASA motor series 50 roller 85 in combination with adapter 4000 952-000		
			

= Article will be sold out. Special orders remain possible.

Conservatory awning Solidare® Verso

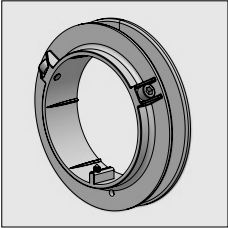
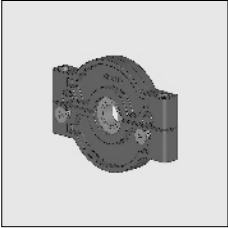
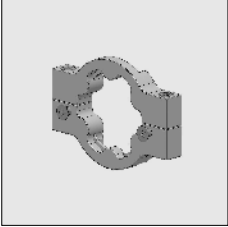
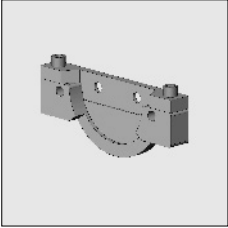
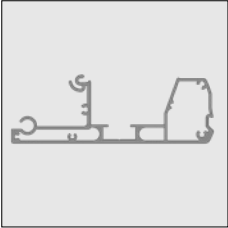
Part number	Description	Paint finish	Length in m ¹ Pack. Unit
	4217 080-000 Nylon cord pulley roller 85		
	4215 114-068 Nylon bearing block incl. precision bearing		
	4215 110-000 Alu motor bracket for Somfy (S)LT motors		
	4215 111-000 Alu motor bracket for ASA motors		
	6252 340-000 Alu front profile Solidare Verso	Mill finish	4.0
	6252 344-000 Idem	Mill finish	5.0
	6252 348-000 Idem	Mill finish	6.0
	6252 340-006 Alu front profile Solidare Verso	RAL 9010 pure white	4.0
	6252 344-006 Idem	RAL 9010 pure white	5.0
	6252 348-006 Idem	RAL 9010 pure white	6.0
	6252 340-901 Alu front profile Solidare Verso	RAL 9001 cream	4.0
	6252 344-901 Idem	RAL 9001 cream	5.0
	6252 348-901 Idem	RAL 9001 cream	6.0
6252 340-755 Alu front profile Solidare Verso (* = Textured)	RAL 7016 anthracite grey*	4.0	
6252 344-755 Idem (* = Textured)	RAL 7016 anthracite grey*	5.0	
6252 348-755 Idem (* = Textured)	RAL 7016 anthracite grey*	6.0	

= Article will be sold out. Special orders remain possible.





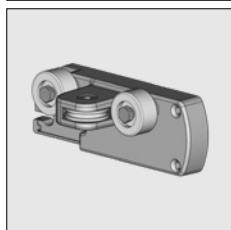
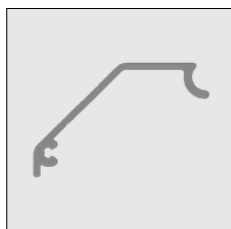
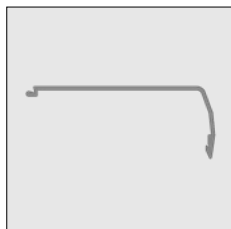

Conservatory awning Solidare® Verso

Part number	Description	Paint finish	Length in m ¹ Pack. Unit
6252 360-000	Alu cover profile-front profile Solidare	Mill finish	4.0
6252 364-000	Idem	Mill finish	5.0
6252 368-000	Idem	Mill finish	6.0
6252 360-006	Alu cover profile-front profile Solidare	RAL 9010 pure white	4.0
6252 364-006	Idem	RAL 9010 pure white	5.0
6252 368-006	Idem	RAL 9010 pure white	6.0
6252 360-901	Alu cover profile-front profile Solidare	RAL 9001 cream	4.0
6252 364-901	Idem	RAL 9001 cream	5.0
6252 368-901	Idem	RAL 9001 cream	6.0
6252 360-755	Alu cover profile-front profile Solidare (* = Textured)	RAL 7016 anthracite grey*	4.0
6252 364-755	Idem (* = Textured)	RAL 7016 anthracite grey*	5.0
6252 368-755	Idem (* = Textured)	RAL 7016 anthracite grey*	6.0
6252 400-000	Alu sealing for front profile Solidare verso	Mill finish	4.0
6252 404-000	Idem	Mill finish	5.0
6252 408-000	Idem	Mill finish	6.0
6252 400-006	Alu sealing for front profile Solidare verso	RAL 9010 pure white	4.0
6252 404-006	Idem	RAL 9010 pure white	5.0
6252 408-006	Idem	RAL 9010 pure white	6.0
6252 400-901	Alu sealing for front profile Solidare verso	RAL 9001 cream	4.0
6252 404-901	Idem	RAL 9001 cream	5.0
6252 408-901	Idem	RAL 9001 cream	6.0
6252 400-755	Alu sealing for front profile Solidare verso	RAL 7016 anthracite grey*	4.0
6252 404-755	Idem	RAL 7016 anthracite grey*	5.0
6252 408-755	Idem (* = Textured)	RAL 7016 anthracite grey*	6.0
4452 087-000	Plate screw countersunk Philips head 3.5 x 32 mm (To fix the sealing to the guide pulley)		100
4217 372-090	Alu guide pulley Solidare Verso, left	Mill finish	
4217 370-090	Idem, right	Mill finish	
4217 372-006	Alu guide pulley Solidare Verso, left	RAL 9010 pure white	
4217 370-006	Idem, right	RAL 9010 pure white	
4217 372-901	Alu guide pulley Solidare Verso, left	RAL 9001 cream	
4217 370-901	Idem, right	RAL 9001 cream	
4217 372-755	Alu guide pulley Solidare Verso, left (* = Textured)	RAL 7016 anthracite grey*	
4217 370-755	Idem, right (* = Textured)	RAL 7016 anthracite grey*	
4210 152-000	Plate screw countersunk Philips head 4.2 x 45 mm (To fix the guide pulley to the front profile)		100

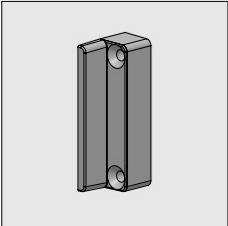

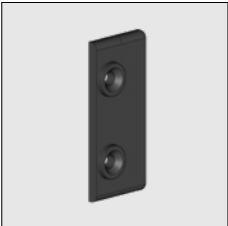
= Article will be sold out. Special orders remain possible.

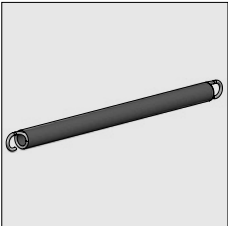
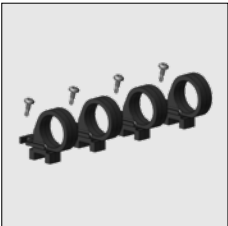
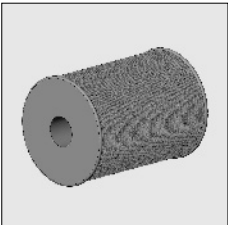
Conservatory awning Solidare® Verso

Part number	Description	Paint finish	Length in m ¹ Pack. Unit
	4452 470-905 Nylon end cap guide pulley bottom part	Black	10
	4452 077-000 Plate screw countersunk Philips head 3.5 x 32 mm (To fix the end cap bottom part to guide pulley/front profile)		100
	4217 399-905 Nylon end cap guide pulley upper part	Black	10
	4452 083-000 Plate screw countersunk Philips head 3.5 x 16 mm (To fix the end cap upper part to the bottom part)		100
	4215 183-000 Stainless steel spring 25 mm, length 350 mm (for projection up to 350 cm)		
	4215 185-000 Stainless steel spring 25 mm, length 570 mm (for projection up to 350 cm)		
Note: The springs are to be stretched up to a max. of 60% of the total spring length.			
ATTENTION !! The pretension must be approximately 30% of the total lengths of the springs. The springs can be pretensioned when the front profile is close to the top cover.			
	4217 460-068 Nylon support block for spring packet per 4 pieces (2 per spring)		
	4215 155-000 Cord 2,5 mm	White	100
	4215 158-000 Stainless steel pulley for cord 2.5 mm with nylon runner		10

= Article will be sold out. Special orders remain possible.

Conservatory awning Solidare® Verso

Part number	Description	Paint finish	Length in m ¹ Pack. Unit
-------------	-------------	--------------	--

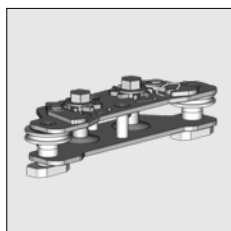

4215 022-068 Cord tensioner Solidare

ATTENTION !!

For this cord tensioner the runners are positioned higher than the similar cord tensioner of the Summerlight®.

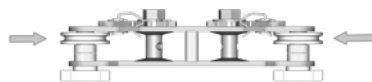

4215 022-068 cord tensioner Solidare

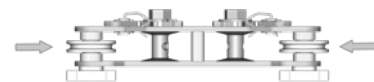

4215 020-068 cord tensioner Summerlight

For large widths (upward of ca. 4.5 m.) the front profile can be supported by the support runner mentioned below and the guiding profile.

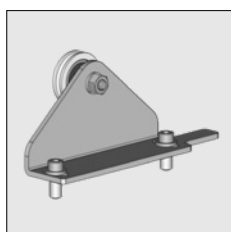

4217 480-090	Support kit for front profile Solidare	Mill finish	
4217 480-006	Idem	RAL 9010 pure white	
4217 480-901	Idem	RAL 9001 cream	
4217 480-755	Idem (* = Textured)	RAL 7016 anthracite grey*	

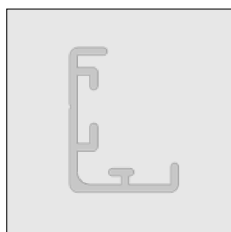

6252 490-000	Alu guiding profile for support kit	Mill finish	7.5
6252 490-006	Idem	RAL 9010 pure white	7.5
6252 490-901	Idem	RAL 9001 cream	7.5
6252 490-755	Idem (* = Textured)	RAL 7016 anthracite grey*	7.5



4452 097-000	(AISI410) drill screw ZB.BK/KK 3.5 x 9.5 mm (To fix the guiding profile to the support beam of the patio roof)		100
--------------	---	--	-----



6297 446-000	Alu cover profile for the guiding profile	Mill finish	7.5
6297 446-006	Idem	RAL 9010 pure white	7.5
6297 446-901	Idem	RAL 9001 cream	7.5
6297 446-755	Idem (* = Textured)	RAL 7016 anthracite grey*	7.5

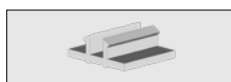

4410 430-080	Nylon snap block for the cover profile		100
--------------	--	--	-----

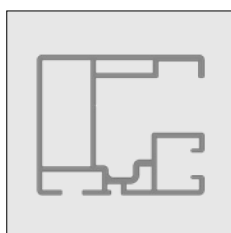

6252 384-000	Alu side guide support Solidare	Mill finish	5.0
6252 388-000	Idem	Mill finish	6.0
6252 394-000	Idem	Mill finish	7.5
6252 384-006	Alu side guide support Solidare	RAL 9010 pure white	5.0
6252 388-006	Idem	RAL 9010 pure white	6.0
6252 394-006	Idem	RAL 9010 pure white	7.5

= Article will be sold out. Special orders remain possible.

Conservatory awning Solidare® Verso

Part number	Description	Paint finish	Length in m ¹ Pack. Unit
6252 384-901	Alu side guide support Solidare	RAL 9001 cream	5.0
6252 388-901	Idem	RAL 9001 cream	6.0
6252 394-901	Idem	RAL 9001 cream	7.5
6252 384-755	Alu side guide support Solidare (* = Textured)	RAL 7016 anthracite grey*	5.0
6252 388-755	Idem	RAL 7016 anthracite grey*	6.0
6252 394-755	Idem	RAL 7016 anthracite grey*	7.5

To fasten to a patio awning, one needs a rivet nut tool.



4090 054-000	Stainless steel countersunk cross screw M 6 x 14 mm To fix the cover support and bearing block set to the side guide support		100
--------------	---	--	-----

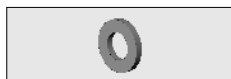

4410 402-000	Stainless steel Washer M6		100
--------------	---------------------------	--	-----

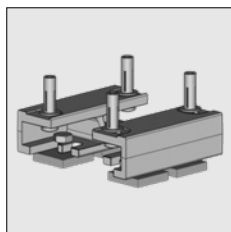

4217 463-090	Alu side guide supports (packet per 2)	Mill finish	
4217 463-006	Idem	RAL 9010 pure white	
4217 463-901	Idem	RAL 9001 cream	
4217 463-755	Idem (* = Textured)	RAL 7016 anthracite grey*	

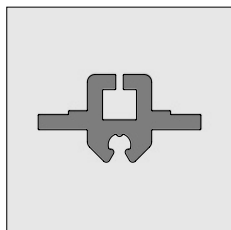

4452 481-008	Nylon guide for single guide	Grey	6.0
4452 485-008	Idem	Grey	7,0
4452 484-008	Idem	Grey	7.5

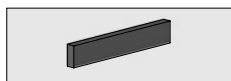

4452 487-000	Neoprene strip 10 x 4 x 60 mm self-adhesive. Use a strip every ± 50 cm on the nylon guide.		135
--------------	---	--	-----

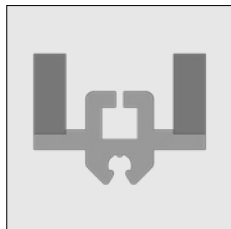

4452 453-068	Nylon guide for single guide and centre guide incl. neoprene strips. Grey Packed in 20 lengths. This article is also available in bulk packaging (500 lengths) 4452 453-008.		7.5
--------------	---	--	-----

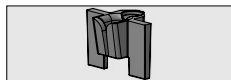

4452 486-008	Nylon funnel for nylon guide	Grey	50
--------------	------------------------------	------	----



4452 070-000	Plate screw countersunk Philips head 2.9 x 19 mm (to fix the funnel on nylon guide)		100
--------------	--	--	-----

= Article will be sold out. Special orders remain possible.

Conservatory awning Solidare® Verso

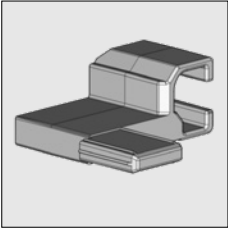
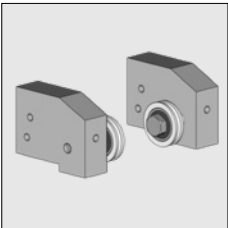
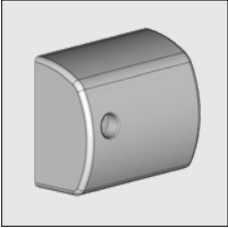
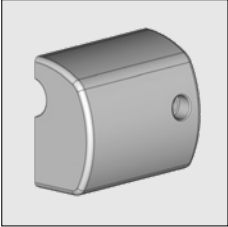
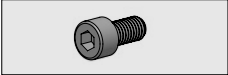
Part number	Description	Paint finish	Length in m ¹ Pack. Unit
	4217 390-000 Alu guide plate for side guide Solidare, left	Mill finish	
	4217 392-000 Idem, right	Mill finish	
	4217 390-006 Alu guide plate for side guide Solidare, left	RAL 9010 pure white	
	4217 392-006 Idem, right	RAL 9010 pure white	
	4217 390-901 Alu guide plate for side guide Solidare, left	RAL 9001 cream	
	4217 392-901 Idem, right	RAL 9001 cream	
	4217 390-755 Alu guide plate for side guide Solidare, left (* = Textured)	RAL 7016 anthracite grey*	
	4217 392-755 Idem, right (* = Textured)	RAL 7016 anthracite grey*	
	4217 386-001 Alu bearing block set Solidare	Silver anodized	
	4217 395-000 Alu end cover left for bearing block 4217 386-001	Mill finish	
	4217 395-006 Idem	RAL 9010 pure white	
	4217 395-901 Idem	RAL 9001 cream	
	4217 395-755 Idem (* = Textured)	RAL 7016 anthracite grey*	
	4217 397-000 Alu end cover right for bearing block 4217 386-001	Mill finish	
	4217 397-006 Idem	RAL 9010 pure white	
	4217 397-901 Idem	RAL 9001 cream	
	4217 397-755 Idem (* = Textured)	RAL 7016 anthracite grey*	
	4217 185-000 Socket-head bolt M 6 x 16 mm cylinder head (To fix end cover to the end bearing)		50

= Article will be sold out. Special orders remain possible.

