

Conservatory awning Summerlight® XL and Summerlight® Verso XL

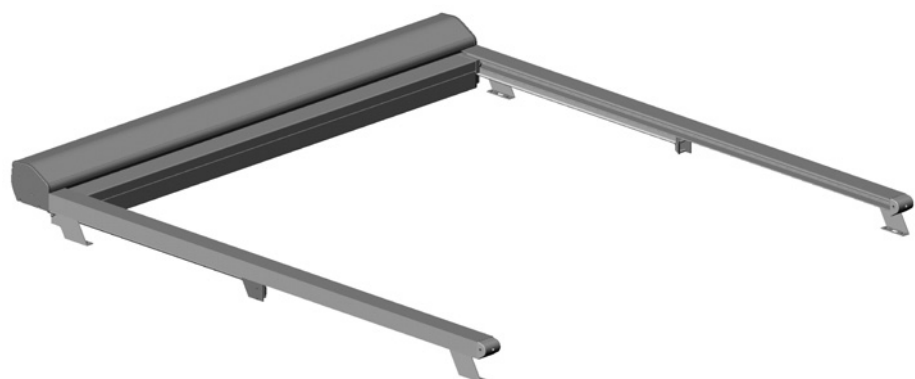

Conservatory awning Summerlight® XL and Summerlight® Verso XL

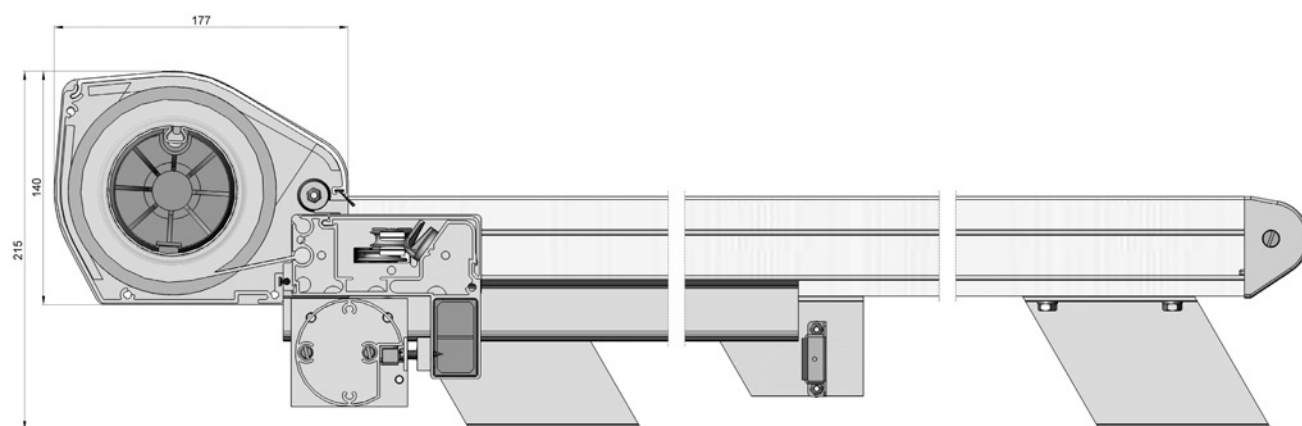
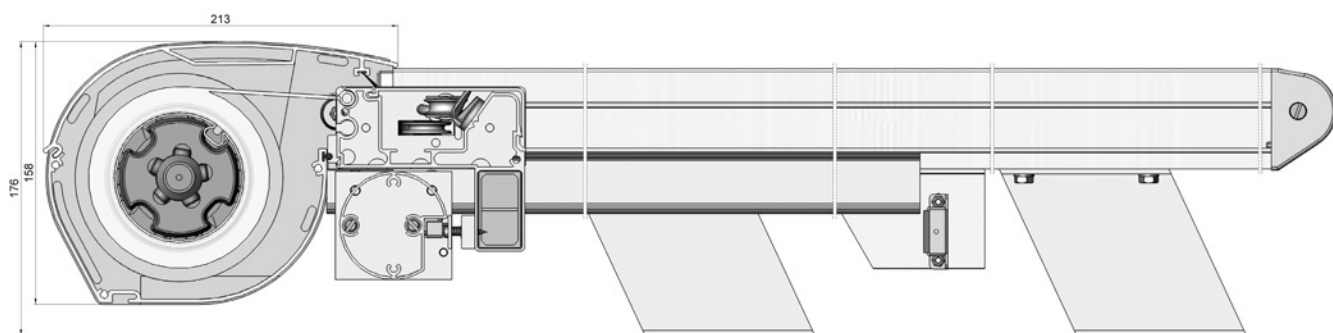

Conservatory awning Summerlight® XL and Summerlight® Verso XL

Part number	Description	Paint finish	Length in m ¹ Pack. Unit
-------------	-------------	--------------	--

When using specific parts of the XL, it is possible to make a conservatory awning in one piece with the following maximum sizes:

Width 6 m.
Projection 4 m.

The parts below will be combined with the parts of the standard Summerlight.

Other particulars:

- Always use a stainless steel spring 4215 185-000 (570 mm) (refer to chapter 7A).
- For projections bigger than approx. 2.5 metres, use the running support roller.

Specific parts:

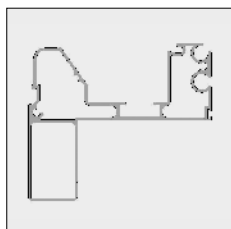

6295 580-000	Alu front profile XL (lower part)	Mill finish	6.0
6295 580-006	Idem	RAL 9010 pure white	6.0
6295 580-007 #	Idem	RAL 8019 grey brown	6.0
6295 580-901	Idem	RAL 9001 cream	6.0
6295 580-916	Idem	RAL 9016 traffic white	6.0
6295 580-755	Idem (* = textured)	RAL 7016 anthracite grey*	6.0

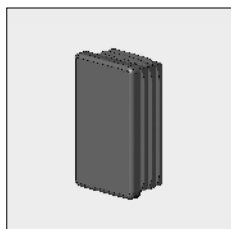

4215 288-000	Nylon sealing cap 50 x 30 mm for front profile (lower part)	Black	
--------------	---	-------	--

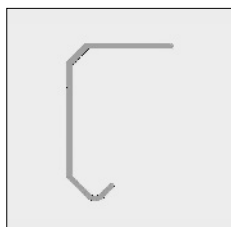

6295 590-000	Alu guiding profile for support roller	Mill finish	6.0
6295 590-006	Idem	RAL 9010 pure white	6.0
6295 590-007 #	Idem	RAL 8019 grey brown	6.0
6295 590-901	Idem	RAL 9001 cream	6.0
6295 590-916	Idem	RAL 9016 traffic white	6.0
6295 590-755	Idem (* = textured)	RAL 7016 anthracite grey*	6.0

Spare parts kit for SUMMERLIGHT and SUMMERLIGHT VERSO XL:

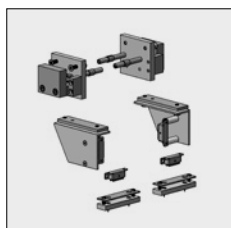

4215 299-090	Spare parts kit for support roller	Mill finish	
4215 299-006	Idem	RAL 9010 pure white	
4215 299-007 #	Idem	RAL 8019 grey brown	
4215 299-901	Idem	RAL 9001 cream	
4215 299-916	Idem	RAL 9016 traffic white	
4215 299-755	Idem (* = textured)	RAL 7016 anthracite grey*	

The above-mentioned kit contains:

- 2 pcs. of guide pulleys + 4 pcs. slide bushes (to be mounted into the support roller)
- 2 pcs. of side guide supports with stopper (with magnetic lock)
- 2 pcs. of magnetic locks incl. fixing material

= Article will be sold out. Special orders remain possible.

Conservatory awning Summerlight® XL and Summerlight® Verso XL

Part number	Description	Paint finish	Length in m ¹ Pack. Unit
6295 600-000	Alu roller	Mill finish	6.0
6295 600-006	Idem	RAL 9010 pure white	6.0
6295 600-007 #	Idem	RAL 8019 grey brown	6.0
6295 600-901	Idem	RAL 9001 cream	6.0
6295 600-916	Idem	RAL 9016 traffic white	6.0
6295 600-755	Idem (* = textured)	RAL 7016 anthracite grey*	6.0

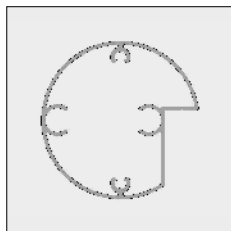

4215 227-068	Alu distance bracket 100 mm, plate and bolts included, left	Mill finish
4215 229-068	Idem, right	Mill finish
4215 227-006	Alu distance bracket 100 mm, plate and bolts included, left	RAL 9010 pure white
4215 229-006	Idem, right	RAL 9010 pure white
4215 227-901	Alu distance bracket 100 mm, plate and bolts included, left	RAL 9001 cream
4215 229-901	Idem, right	RAL 9001 cream
4215 227-916	Alu distance bracket 100 mm, plate and bolts included, left	RAL 9016 traffic white
4215 229-916	Idem, right	RAL 9016 traffic white
4215 227-755	Alu distance bracket 100 mm, plate and bolts included, left (* = Textured)	RAL 7016 anthracite grey*
4215 229-755	Idem, right (* = Textured)	RAL 7016 anthracite grey*

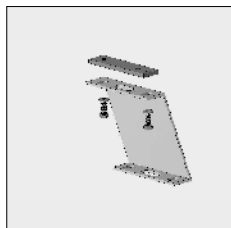

4215 240-090	Alu U-shape bracket (15 x 30 x 15 x 3 mm) for placement under 4215 227/229/297/226/228/296-... in case of 4215 296/297-... cutting through the middle	Mill finish
4215 240-006	Idem	RAL 9010 pure white
4215 240-007	Idem	RAL 8019 grey brown
4215 240-901	Idem	RAL 9001 cream
4215 240-916	Idem	RAL 9016 traffic white

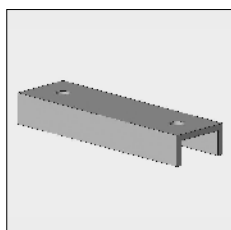

= Article will be sold out. Special orders remain possible.