

SolidScreen Niche XS

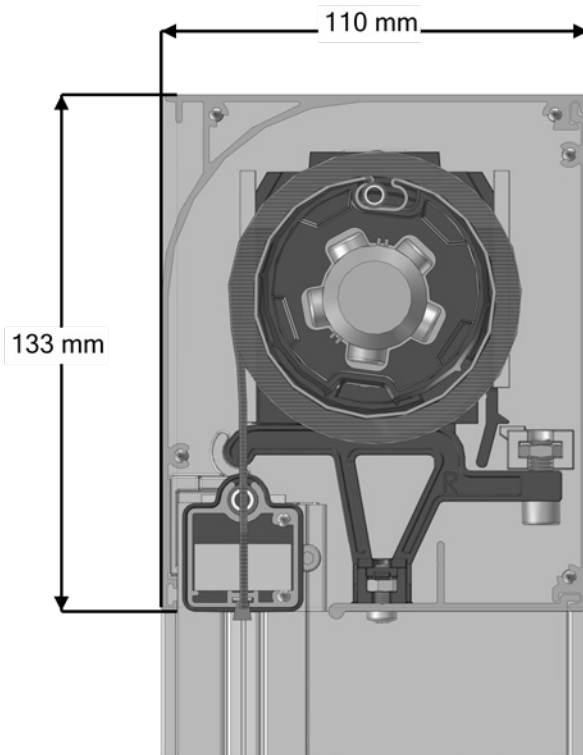

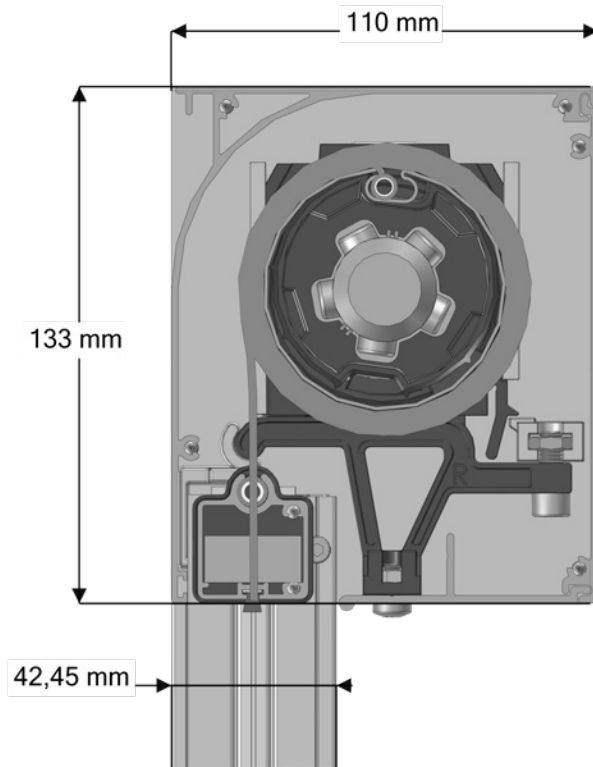





SolidScreen Niche XS

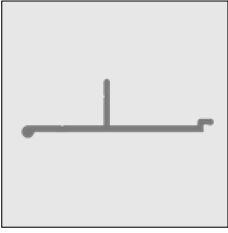
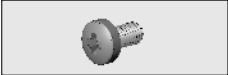

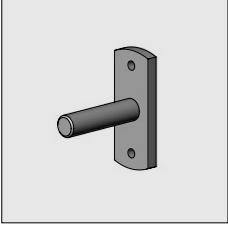

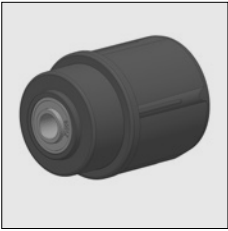

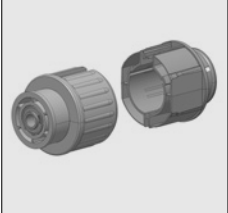
Part number	Description	Paint finish	Length in m ¹ Pack. Unit
4453 500-000	Alu end fix bracket Niche XS, left	Mill finish	
4453 505-000	Idem, right	Mill finish	
4453 525-905	Kit fastening plates Niche XS with motor left consists of: Fastening bracket L+R Fastening plate R for bearing pin To fasten the Bearing pin or motor (Somfy or ASA) Motorplate left for Somfy motor	Black	10
4453 527-905	Kit fastening plates Niche XS with motor left consists of: Fastening bracket L+R Fastening plate L for bearing pin For fixing the Bearing pin or motor (Somfy or ASA) Motorplate right for Somfy motor	Black	10
4217 185-000	Stainless steel socket-head cylinder bolt M6 x 16 mm (For fixing the fastening bracket to the end fix bracket)		50
4453 242-000	Stainless steel nut M 6		100
6298 400-000	Alu top cover Niche XS	Mill finish	7.0
6298 307-000	# Alu centre piece top cover Niche XS	Mill finish	4.1
6298 308-000	# Alu centre piece top cover Niche XS	Mill finish	5.1
6298 305-000	Alu centre piece top cover Niche XS	Mill finish	7.0
6298 305-016	# Idem	Silver anodized	7.0
6298 305-006	Idem	RAL 9010 pure white	7.0
6298 305-901	# Idem	RAL 9001 cream	7.0
6298 305-716	# Idem	RAL 7016 anthracite grey	7.0
4452 083-000	Plate screw countersunk Philips head 3.5 x 16 mm (For fixing the top cover and centre piece top cover to the end fix bracket)		100

= Article will be sold out. Special orders remain possible.

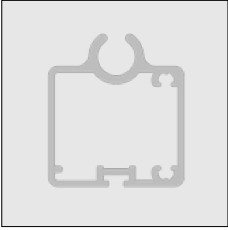
SolidScreen Niche XS

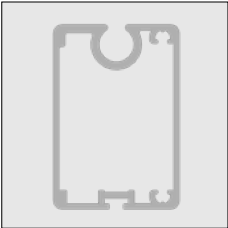
Part number	Description	Paint finish	Length in m ¹ Pack. Unit
6298 410-000	Alu bottom cover Niche XS	Mill finish	7.0
			
4453 244-000	Stainless steel countersunk cross screw M4 x 12 mm (For fixing the bottom cover to the fastening bracket)		100
			
4210 981-000	Stainless steel nut M4 (For fixing the bottom cover to the fastening bracket)		100
			
4210 498-080	Bearing pin 12 mm with fixing plate	Zinc-plated	10
			
4000 151-000	Senkschraube rostfrei, mit Kreuzschlitz M6 x 12 mm (For fixing bearing pin to the fasteningplate)		100
			
4453 051-068	Nylon bearing roller bung SolidScreen Niche XS for tube 63 Incl. 2 precision bearings with increased inner ring.	Black	
			
4453 055-905	Nylon Motor roller bung SolidScreen XS for tube 63 In combination with: ASA Motor Serie 50 or Somfy Motor Serie 50	Black	10
			
4453 590-068	Set bearing roller bung + Adaption roller bung SolidScreen XS for tube 78 Incl. 2 precision bearings with increased inner ring.	Black	10
			

= Article will be sold out. Special orders remain possible.

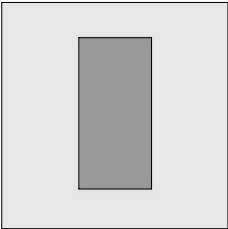
Part number	Description	Paint finish	Length in m ¹ Pack. Unit
	6297 860-000 Alu bottom slat SolidScreen Niche and Niche XS	Mill finish	7.0
	6297 860-016 Idem	Silver anodized	7.0
	6297 860-006 Idem	RAL 9010 pure white	7.0
	6297 860-901 Idem	RAL 9001 cream	7.0
	6297 860-716 Idem	RAL 7016 anthracite grey	7.0
	4453 220-905 Nylon end cap kit for bottom slat Niche consists of: - End cap bottom slat front L+R - End cap bottom slat rear L+R	Black	10
Below mentioned heavy bottom slat is intended for additional stability for wide screens and extra weight (double reinforcement 6253 067-000) for high screens. For the guidelines applying reinforcement, please look at the manufacturing and installation instruction.			
	6298 600-000 Alu bottom slat Xtra/XL/Niche/Niche XS heavy	Mill finish	7.0
	4453 883-905 Nylon end cap bottom slat heavy front	Black	
	4453 884-905 Nylon end cap bottom slat heavy rear	Black	
	4452 555-000 Stainless steel plate screw with countersunk Philips head 3,5 x 25 (for fixing the end caps to the bottom slat)		100
	6253 067-000 Steel reinforcement strip 25 x 12 mm for bottom slat SolidScreen (After cutting the reinforcement strip, treat the cutted side with alu zinc spray part no. 5760 273-000 refer to chapter 9B)	Zinc-plated	3.05

= Article will be sold out. Special orders remain possible.

SolidScreen Niche XS

Part number	Description	Paint finish	Length in m ¹ Pack. Unit
-------------	-------------	--------------	--

Below mentioned reinforcement strip 16 x 12 mm fits 2x in bottom slat Niche. Apply in high small screens.

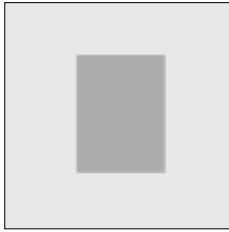

6253 062-000	Steel reinforcement strip 16 x 12 mm for bottom slat SolidScreen Niche (After cutting the reinforcement strip, treat the cutted side with alu zinc spray part no. 5760273-000 refer to chapter 9B)	Zinc-plated	3.1
--------------	--	-------------	-----

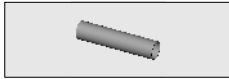

6297 740-000	Nylon tube. To be used as as padding between 2 pieces reinforcement in the bottom slats Solidscreen.	grey	4.0
--------------	--	------	-----

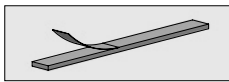

4452 238-000	Neoprene strip 10 x 2 mm self-adhesive, for suppression of impact sound between the bar and the bottom slat.		50
--------------	--	--	----

One can choose the bristle 5 mm or 8 mm to shove into the bottom slat:



4452 277-000	Bristle 5 mm for bottom slat SolidScreen	Grey	100
--------------	--	------	-----



4452 276-000	Bristle 8 mm for bottom slat SolidScreen	Grey	100
--------------	--	------	-----

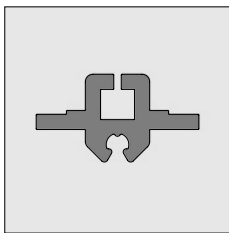

4452 283-000	PVC (soft) inlay, bottom slat SolidScreen	Black	300
--------------	---	-------	-----

4452 283-068	Idem, length 7.0 m.	Black	7.0
--------------	---------------------	-------	-----

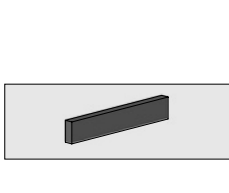

4452 481-008	Nylon guide for single guide and centre guide	Grey	6.0
--------------	---	------	-----

4452 485-008	Idem	Grey	7.0
--------------	------	------	-----

4452 484-008	Idem	Grey	7.5
--------------	------	------	-----

The side guides can be delivered incl. neoprene strips. Only in lengths of 7500 mm. Please contact the sales department for information about the minimum quantity and delivery time.

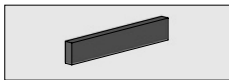

4452 487-000	Neoprene strip 10 x 4 x 60 mm self-adhesive. Install every 50 cm approx. on the nylon guide of the SolidScreen (4452 485-008)		135
--------------	---	--	-----

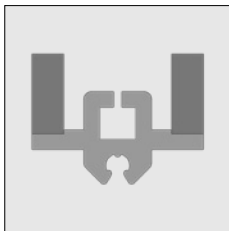

4452 453-068	Nylon guide for single guide and centre guide SolidScreen incl. neoprene strips. Packed in 20 lengths. This article is also available in bulk packaging (500 lengths) 4452 453-008.	Grey	7.5
--------------	---	------	-----



4452 486-008	Nylon funnel for side guide (4452 485-008)	Grey	50
--------------	--	------	----



4452 070-000	Plate screw with countersunk Philips head 2.9 x 19 mm (For fixing the funnel on nylon side guide)		100
--------------	---	--	-----

= Article will be sold out. Special orders remain possible.

Part number	Description	Paint finish	Length in m ¹ Pack. Unit
-------------	-------------	--------------	--

The below mentioned parts are for the standard side guide

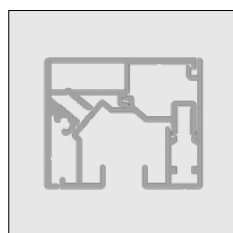

4453 239-001 The total size of the low side guide is 35 x 42.5 mm

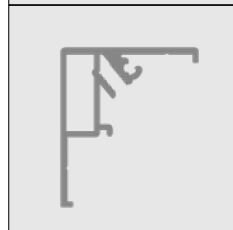

6298 420-000 Alu side guide SolidScreen Niche XS rear side Mill finish 7.0

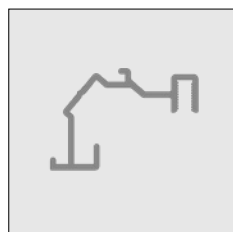

6298 425-000 Alu side guide SolidScreen Niche XS front side Mill finish 7.0



4453 219-000 Stainless steel socket-head bolt M4 x 10 mm cylinder head (For fixing the side guide front side to the side guide rear side) 100

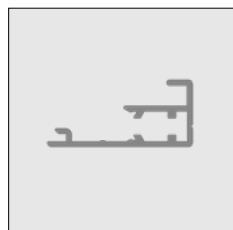

6298 430-000 Alu cover profile for side guide Niche XS Mill finish 7.0

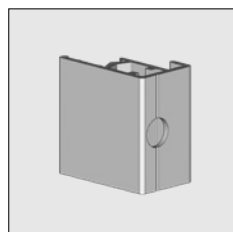

4453 239-001 Alu filling piece for side guide Solidscreen Niche XS Silver anodized 2

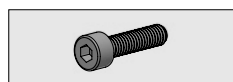

4452 123-000 Stainless steel socket-head bolt M4 x 16 mm cylinder head (For fixing the cover profile to the side guide) 100

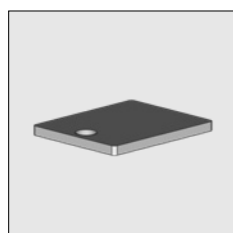

4453 542-000 Alu end cap universal for low side guide Niche XS Mill finish

= Article will be sold out. Special orders remain possible.

SolidScreen Niche XS

Part number	Description	Paint finish	Length in m ¹ Pack. Unit
-------------	-------------	--------------	--



4452 073-000 Plate screw with countersunk Philips head 3.5 x 19 mm
(For fixing the end cap to the side guide)

100

The below mentioned parts are for the high side guide

The total size of the side guide is 35 x 110 mm

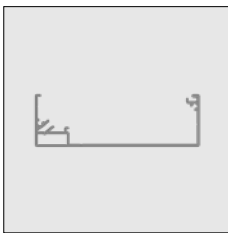
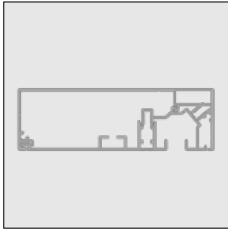

6298 435-000 Alu side guide SolidScreen Niche XS rear side

Mill finish

7.0

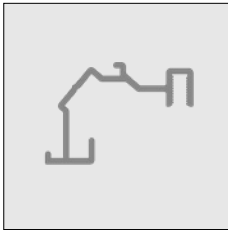

6298 425-000 Alu side guide SolidScreen Niche XS front side

Mill finish

7.0



4453 219-000 Stainless steel socket-head bolt M4 x 10 mm cylinder head
(For fixing the side guide front side to the side guide rear side)

100

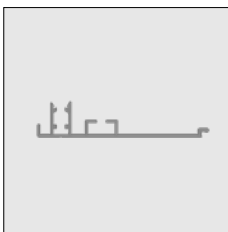

6298 440-000 Alu cover profile for side guide SolidScreen Niche XS

Mill finish

7.0

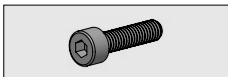

4452 123-000 Stainless steel socket-head bolt M4 x 16 mm cylinder head
(For fixing the cover profile to the filling piece to the side guide)

100

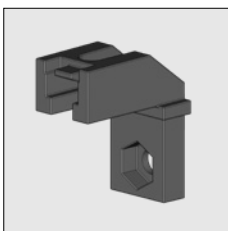

4453 235-905 Nylon clamping block bottom profile Niche XS
(For fixing the cover profile Niche XS)

Black

10

= Article will be sold out. Special orders remain possible.

SolidScreen Niche XS

Part number	Description	Paint finish	Length in m ¹ Pack. Unit
4452 086-000	Cross screw, cylinder screw 4 x 6 mm (For fixing the clamping block to the cover profile for side guide)		100
4453 244-000	Cross screw, cylinder screw 4 x 12 mm (For fixing the bottom profile to the clamping block)		100
4210 981-000	Stainless steel nut M4 (For fixing the clamping block)		100
4453 239-001	Alu filling piece for side guide Solidscreen Niche XS	Silver anodized	2
4453 555-000	Nylon end caps left for side guide Niche	Mill finish	
4453 557-000	Idem, right	Mill finish	
4452 073-000	Plate screw countersunk Philips head 3.5 x 19 mm (For fixing the end cap to the side guide)		100

Further requirements:
- Rollers refer to Chapter 1

= Article will be sold out. Special orders remain possible.