

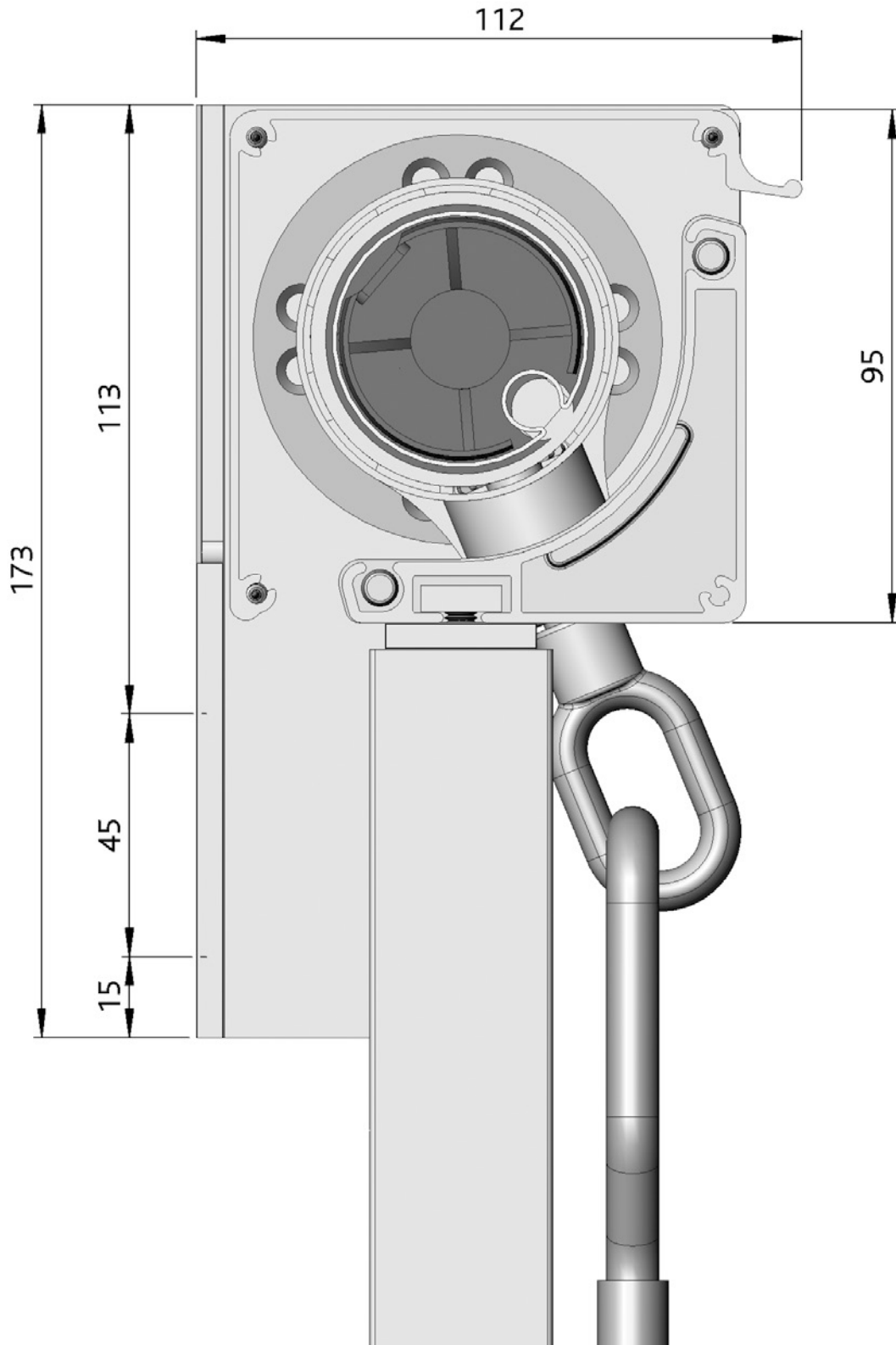

Vista Elégance® 95 basic and special

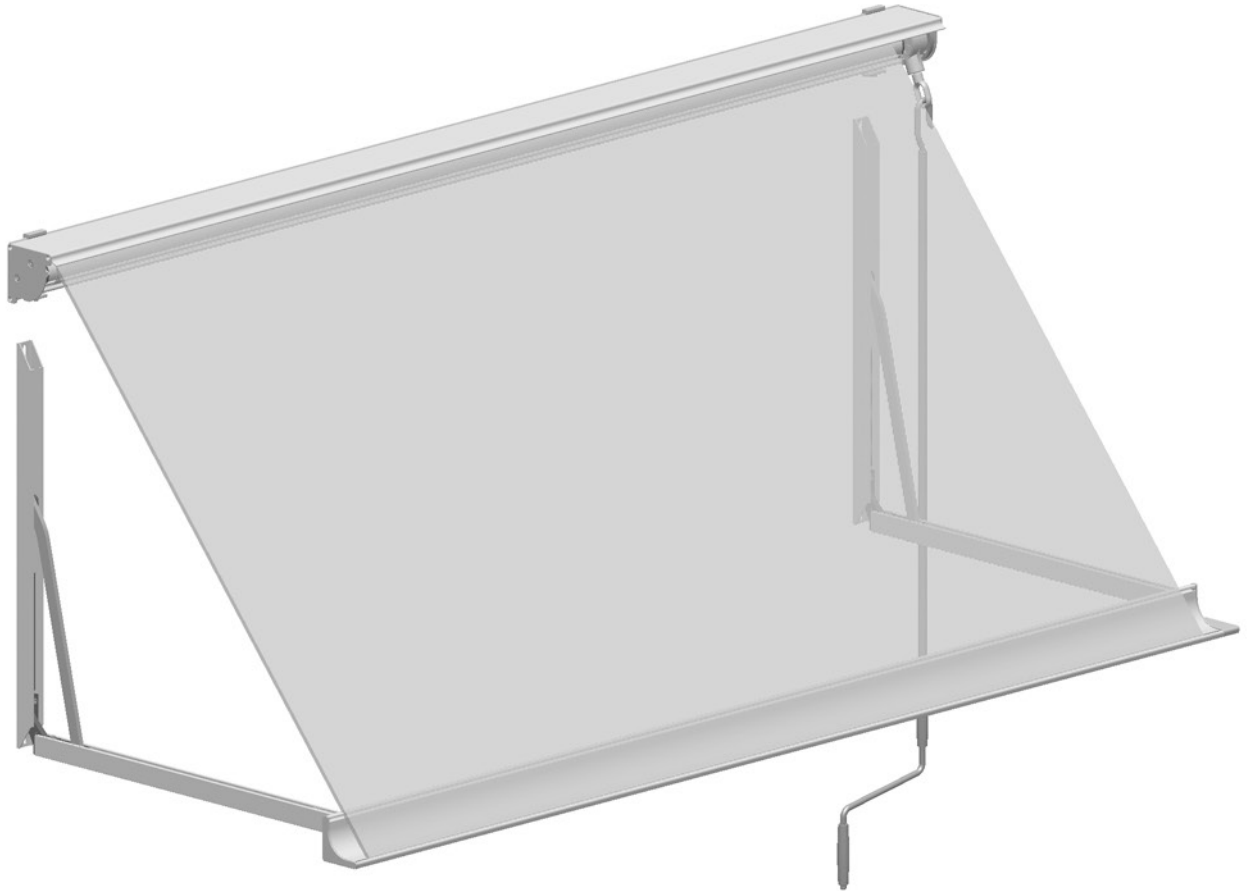

4



Vista Elégance® 95 basic and special

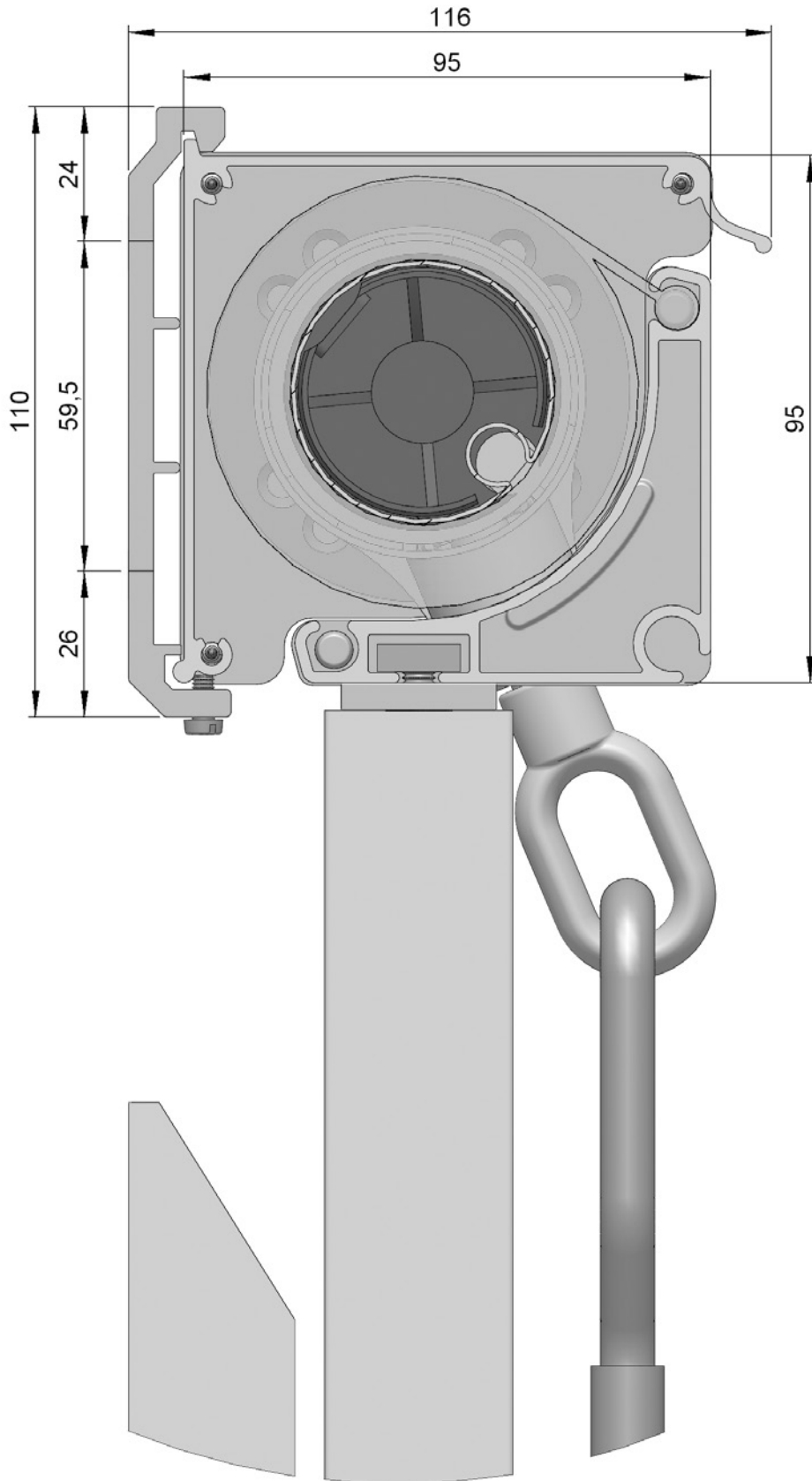

4

Vista Elégance® 95 basic and special

Part number	Description	Paint finish	Length in m ¹ Pack. Unit
4465 060-090	Alu end fix bracket Elégance 95 basic, left	Mill finish	
4465 061-090	Idem, right	Mill finish	
4465 060-001	Alu end fix bracket Elégance 95 basic, left	Silver anodized	
4465 061-001	Idem, right	Silver anodized	
4465 060-006	Alu end fix bracket Elégance 95 basic, left	RAL 9010 pure white	
4465 061-006	Idem, right	RAL 9010 pure white	
4465 060-901	Alu end fix bracket Elégance 95 basic, left	RAL 9001 cream	
4465 061-901	Idem, right	RAL 9001 cream	
4465 070-090	Alu end fix bracket Elégance 95 halfround with recess for front profile, left	Mill finish	
4465 072-090	Idem, right	Mill finish	
4465 070-001	Alu end fix bracket Elégance 95 halfround with recess for front profile, left	Silver anodized	
4465 072-001	Idem, right	Silver anodized	
4465 070-006	Alu end fix bracket Elégance 95 halfround with recess for front profile, left	RAL 9010 pure white	
4465 072-006	Idem, right	RAL 9010 pure white	
4465 070-901	Alu end fix bracket Elégance 95 halfround with recess for front profile, left	RAL 9001 cream	
4465 072-901	Idem, right	RAL 9001 cream	
4452 055-001	Alu bearing block 95, with plate, without screws	Silver anodized	10
4452 055-006	Alu bearing block 95, with plate and screws	RAL 9010 pure white	
4452 055-901	Alu bearing block 95, with plate and screws	RAL 9001 cream	
4000 270-000	Stainless steel screw with Philips cylinder head M6 x 12 mm (For fixing the bearing block plate and top cover to the alu bearing block)		100
4000 158-000	Stainless steel screw with countersunk Philips head M6 x 18 mm (For fixing the bearing block to the top cover support)		100
4460 017-000	Precision bearing with dust seal, spindle hole 15 mm (for alu bearing block)		10
4460 020-080	Nylon adapter bush from 15 to 12 mm (for precision bearing)		100
4460 014-080	Nylon patent bearing, spindle hole 12 mm (for alu bearing block)		100

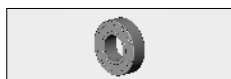
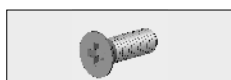
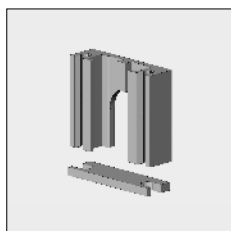
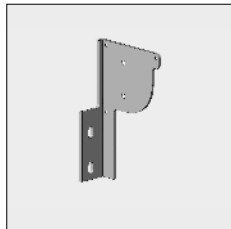
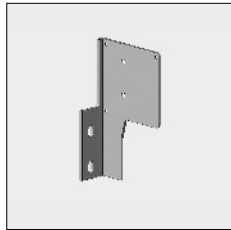

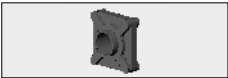
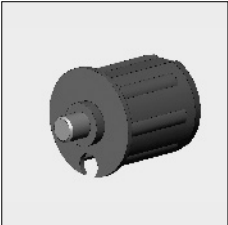
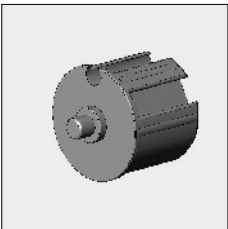
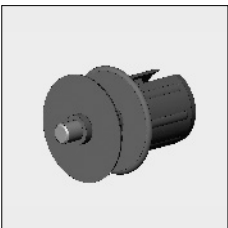
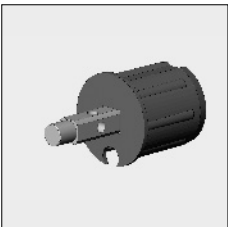
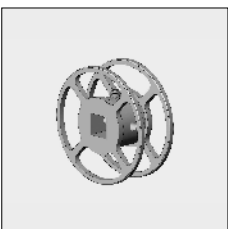
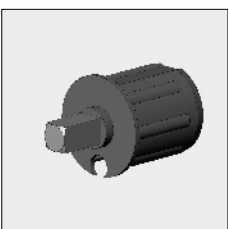

= Article will be sold out. Special orders remain possible.

Vista Elégance® 95 basic and special

Part number	Description	Paint finish	Length in m ¹ Pack. Unit
	4460 016-080 Nylon square bearing, spindle hole 12 mm (for alu bearing block)		25
	4470 050-080 Nylon bearing roller bung 48, with spindle 12 mm		25
	4469 050-068 Alu (extruded) bearing roller bung 48, with spindle 12 mm		
	4470 030-080 Nylon bearing roller bung 63, with spindle 12 mm		25
	4469 060-068 # Alu (extruded) bearing roller bung 63, with spindle 12 mm		
	4470 054-080 Nylon bearing roller bung 48 with nylon pulley 70 mm, with spindle 12 mm		25
	4469 058-068 Nylon pulley roller bung 48, with spindle 12 mm		
	4469 052-068 Alu (extruded) pulley roller bung 48, with spindle 12 mm		
	4469 068-068 Nylon pulley roller bung 63, with spindle 12 mm		
	4469 062-068 Alu (extruded) pulley roller bung 63, with spindle 12 mm		
	4469 070-068 Alu (extruded) manual tape pulley 70 mm, used for C34 for pulley roller bung pin 4469 058/052/068/062-068		
	4470 062-080 Nylon mono plug 48 with square spindle 13 x 30 mm		25
	4469 056-068 Alu (extruded) mono plug 48, with square spindle 13 x 25 mm		

= Article will be sold out. Special orders remain possible.

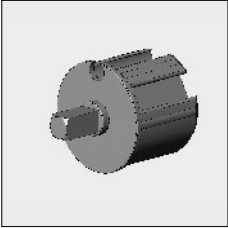
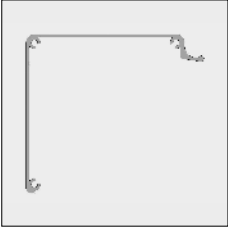
Vista Elégance® 95 basic and special

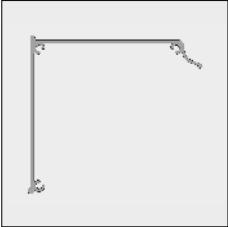
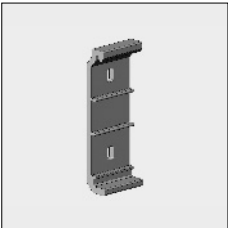
Part number	Description	Paint finish	Length in m ¹ Pack. Unit	
	4470 032-080	Nylon mono plug 63 with square spindle 13 x 25 mm	25	
	4469 066-068	Alu (extruded) mono plug 63, with square spindle 13 x 25 mm		
	6296 521-000	Alu top cover Elégance 95	Mill finish 7.0	
	6296 520-000	Idem	Mill finish 7.5	
	6296 520-016	Alu top cover Elégance 95	Silver anodized 7.5	
	6296 521-006	Alu top cover Elégance 95	RAL 9010 pure white 7.0	
	6296 521-901	Alu top cover Elégance 95	RAL 9001 cream 7.0	
	4452 081-000	Plate screw with countersunk Philips head 3.9 x 16 mm (For fixing the side plate to top cover).	100	
For fixing the top cover Silver anodized:				
	4452 080-000	Plate screw with countersunk Philips head 4.2 x 16 mm	100	
	6296 526-000	Alu top cover Elégance 95 special	Mill finish 7.0	
	6296 525-000	Idem	Mill finish 7.5	
	6296 526-016	Alu top cover Elégance 95 special	Silver anodized 7.0	
	6296 525-016	Idem	Silver anodized 7.5	
	6296 526-006	Alu top cover Elégance 95 special	RAL 9010 pure white 7.0	
	6296 525-006	Idem	RAL 9010 pure white 7.5	
	6296 526-901	Alu top cover Elégance 95 special	RAL 9001 cream 7.0	
	6296 525-901	Idem	RAL 9001 cream 7.5	
		4452 908-090	Alu wall bracket without socket-head screw M6 x 10 mm	Mill finish
		4452 908-001	Idem, incl. socket-head screw	Silver anodized 10
4452 908-006		Idem, incl. socket-head screw	RAL 9010 pure white 10	
4452 908-901		Idem, incl. socket-head screw	RAL 9001 cream 10	

= Article will be sold out. Special orders remain possible.

Vista Elégance® 95 basic and special

Part number	Description	Paint finish	Length in m ¹ Pack. Unit
-------------	-------------	--------------	--

Please use the ceiling brackets below in combination with wall bracket 4452 908-...

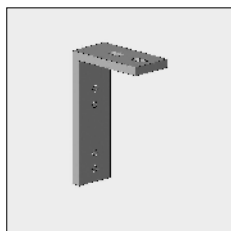

4452 924-090	Alu ceiling bracket	Mill finish	
4452 924-008	Idem	RAL 7035 light grey	
4452 924-006	Idem	RAL 9010 pure white	
4452 924-901	Idem	RAL 9001 cream	

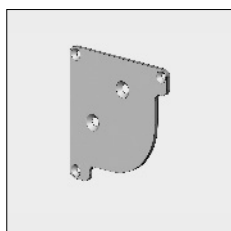

4452 063-090	Alu side plate for Elégance 95 special	Mill finish	
4452 063-001	Idem	Silver anodized	
4452 063-006	Idem	RAL 9010 pure white	
4452 063-901	Idem	RAL 9001 cream	

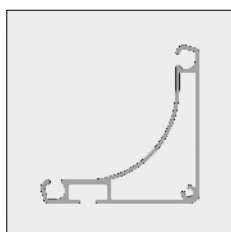

6296 541-000	Alu front profile Elégance 95, basic	Mill finish	7.0
6296 540-000	Idem	Mill finish	7.5
6296 541-016	Alu front profile Elégance 95, basic	Silver anodized	7.0
6296 540-016	Idem	Silver anodized	7.5
6296 541-006	Alu front profile Elégance 95, basic	RAL 9010 pure white	7.0
6296 540-006	Idem	RAL 9010 pure white	7.5
6296 541-901	Alu front profile Elégance 95, basic	RAL 9001 cream	7.0
6296 540-901	Idem	RAL 9001 cream	7.5

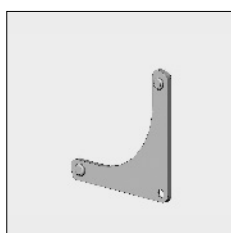

4410 405-000	Alu end cap front profile Elégance 95 basic	Mill finish	
4410 405-001	Idem	Silver anodized	
4410 405-006	Idem	RAL 9010 pure white	
4410 405-901	Idem	RAL 9001 cream	

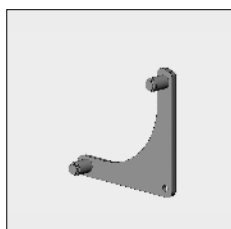

4410 406-080	Nylon end cap front profile Elégance 95, basic	Grey	50
4410 407-080	Idem	Black	50



4452 081-000	Plate screw with countersunk Philips head 3.9 x 16 mm (For fixing the end caps to the front profile without valance groove)		100
--------------	--	--	-----

= Article will be sold out. Special orders remain possible.

Vista Elégance® 95 basic and special

Part number	Description	Paint finish	Length in m ¹ Pack. Unit
-------------	-------------	--------------	--

For tape operation, a steel wire or gear box, the front profile can be provided with a front profile spacer:

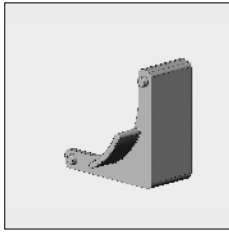

4452 064-008	Alu end cap/front profile spacer, left	RAL 7035 light grey	
4452 066-008	Idem, right	RAL 7035 light grey	

4452 066-006	Alu end cap/front profile spacer, right	RAL 9010 pure white	
--------------	---	---------------------	--

4452 064-901	Alu end cap/front profile spacer, left	RAL 9001 cream	
4452 066-901	Idem, right	RAL 9001 cream	

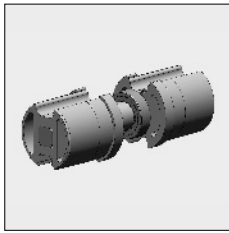

4469 054-068	Alu (extruded) couple bearing with precision bearing for rollers in steel 48 and in alu 50		
--------------	--	--	--

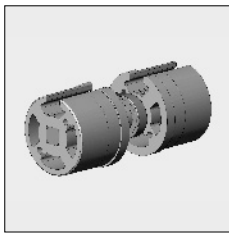

4469 064-068	Alu (extruded) couple bearing with precision bearing for rollers in steel 63		
--------------	--	--	--

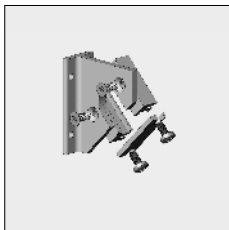

4452 062-001	Alu coupler with bearing block and plate (for couple bearing)	Silver anodized	
--------------	---	-----------------	--

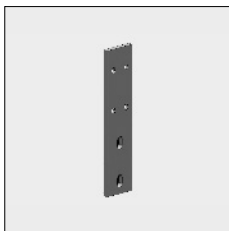

4452 061-090	Alu wall plate (for coupler 4452 062-001)	Mill finish	
4452 061-001	Idem	Silver anodized	
4452 061-006	Idem	RAL 9010 pure white	
4452 061-901	Idem	RAL 9001 cream	

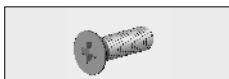

4000 152-000	Stainless steel screw with countersunk Philips head M6 x 20 mm (For fixing coupling bracket to wall plate)		100
--------------	---	--	-----

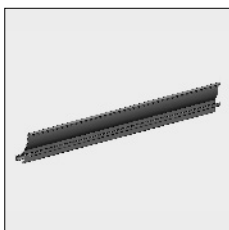

4452 057-068	Alu joint for front profiles Elégance 95 (length 24 cm)	Mill finish	
--------------	---	-------------	--

Further requirements:
 - Rollers refer to chapter 1
 - Drop arms, units and top sections refer to chapter 4H

= Article will be sold out. Special orders remain possible.